

Burner Systems:

G45-2-16/19(P)
 G45-2-18/20(P)
 G45-2-24(P)
 G45-2-30(P)
 G45-2-36(P)
 G45-2-42(P)
 G45-2-48(P)
 G45-2-60(P)



**Design Certified
to:
Z21.84b-2004
(16/19" - 30" models)**

**FOR INSTALLATION IN
SEE-THRU SOLID-FUEL
BURNING FIREPLACES***

G45-2 SERIES VENTED GAS LOG SET (UNREGULATED)

WARNING

If the information in this manual is not followed exactly, a fire or explosion may result, causing property damage, personal injury, or loss of life.

Do not store or use gasoline or other flammable vapors and liquids in the vicinity of this or any other appliance.

WHAT TO DO IF YOU SMELL GAS:

- Open a window.
- Do not try to light any appliance.
- Do not touch any electrical switch; do not use any phone in the building.
- Immediately call the gas supplier from a neighbor's phone. Follow gas supplier's instructions.
- If you cannot reach the gas supplier, call the fire department.

Installation and service must be performed by a qualified professional installer, service agency, or the gas supplier.

This appliance is only for use with the type of gas indicated on the rating plate.

IMPORTANT: READ THESE INSTRUCTIONS CAREFULLY BEFORE STARTING INSTALLATION OF THE LOG SET

The Real-Fyre gas log set is to be installed only in a solid-fuel burning fireplace with a working flue and constructed of noncombustible material. The installation, including provisions for combustion and ventilation air must conform with the *National Fuel Gas Code, ANSI Z223.1/NFPA 54*, or the *CSA B149.1, Natural Gas and Propane Installation Code*, and applicable local building codes.

A damper clamp is included to maintain the minimum permanent vent opening and to prevent full closure of the damper blade. **The chimney damper MUST be fully opened when burning the log set. The log set is designed to burn with yellow flames; thus adequate ventilation is absolutely necessary.**

To comply with certification, listings, and building code acceptances, and for safe operation and proper performance of this log set, use ONLY Peterson parts and accessories. Use of other controls, parts, and accessories that are not designed for use with Real-Fyre gas log sets is prohibited and will void all warranties, certifications, listings, and building code approvals, and may cause property damage, personal injury, or loss of life.

***Note:** Solid-fuels shall not be burned in a fireplace where a decorative appliance is installed.



**INSTALLER:
Leave this manual with the appliance.
CONSUMER:
Retain this manual for future reference.**



TABLE OF CONTENTS

TABLE OF CONTENTS	2
GENERAL INFORMATION	2
PARTS LIST	3
IMPORTANT PRE-INSTALLATION AND FIREPLACE SAFETY INFORMATION	4
INSTALLATION	5
INSTALLING THE BURNER	5
GRANULE, EMBER, AND GRATE PLACEMENT	6
G45-2-xx-01(M)(P) MODELS ONLY	7
LOG PLACEMENT	8
LIGHTING INSTRUCTIONS - MANUAL VALVE	9
EXAMPLE LOG PLACEMENTS	10
TROUBLESHOOTING YOUR GAS LOG SET	12
WARRANTY	14

GENERAL INFORMATION

Keep the area of the gas log set clear and free from combustible materials, gasoline, and other flammable vapors and liquids.

Periodically remove the logs and examine the burner assembly. If dirty, clean with a stiff brush. Also, examine the area around the burner air shutter and pilot, removing any dirt or lint. Occasional cleaning will ensure long life and trouble-free operation. An annual inspection and cleaning of the vent system by a qualified agency is recommended.

Burner size	Min. Fireplace Dimensions			BTU	
	Width*	Depth	Height	NAT.	L.P.
16/19"	25"	15"	18"	45k	35k
18/20"	26"	17"	18"	80k	65k
24"	30"	17"	18"	90k	75k
30"	36"	17"	18"	90k	75k
[36"]	42"	22"	18"	130kk	100k
[42"]	48"	22"	18"	150k	120k
[48"]	54"	22"	18"	170k	130k
[60"]	66"	22"	18"	190k	140k

* This required width allows for centering of the log set. Add 4" to front width if the burner is to be installed with a pilot kit.

Note: Bracketed sizes indicate non-certified burner systems.

Minimum Free Opening Area of Chimney Damper for Venting (sq. in.)								
For Factory-Built Fireplaces *								
Chimney Height	16/19"	18/20"	24"	30"	36"	42"	48"	60"
15' (min.)	29	50	57	57	82	94	107	119
20'	26	45	51	51	73	85	96	107
30'	23	41	46	46	66	76	86	96

* For Masonry-Built Fireplaces; add 4 sq. in. to amount shown.

GENERAL INFORMATION (Cont.)

The Real-Fyre® gas log set is to be installed only in a fully vented, noncombustible fireplace with an open damper. The chimney must be free of any obstructions. The fireplace must be designed and approved to burn wood.

The fireplace must have a gas-supply line that has been installed by a qualified technician in accordance with all local codes. The gas-supply line must be 1/2" minimum interior diameter. If the gas line to the fireplace is longer than 20', a larger-diameter line may be necessary.

Be sure to clean the fireplace floor of any ashes or other foreign materials. It is recommended that the fireplace and chimney be inspected by a chimney sweep or other qualified person before you install the Real-Fyre® gas log set.

Required Gas Pressure: The minimum inlet gas-supply pressure for the purpose of input adjustment is 7" water column (w.c.) for natural gas and 11" w.c. for propane gas. The maximum inlet gas-supply

pressure is 10.5" w.c. for natural gas and 13" w.c. for propane gas.

Testing the Gas-Supply System: The gas log set and its individual shutoff valve must be disconnected from the gas-supply piping system while performing any tests of the piping system at pressures in excess of 1/2 psig. The gas log set must be isolated from the gas-supply piping system by closing its individual manual shutoff valve during any pressure testing of the gas-supply piping system at test pressures equal to or less than 1/2 psig.

A fireplace screen must be in place when the system is burning. Provisions for adequate combustion air must be maintained. Unless other provisions for combustion air are provided, the screen shall have an opening(s) for introduction of combustion air. Combustion air is adequate when all flames curl into the fireplace and away from the screen. **When a glass fireplace enclosure (door) is used, leave the doors fully open when the system is in operation.**

PARTS LIST

The log set is purchased and packaged separately. Golden Oak log set shown here. Styles and sizes will vary depending upon the log set ordered. If the log set ordered includes placement instructions; follow those instructions. When ordering replacement parts; be sure to indicate your log set model.

Fig. 3-1

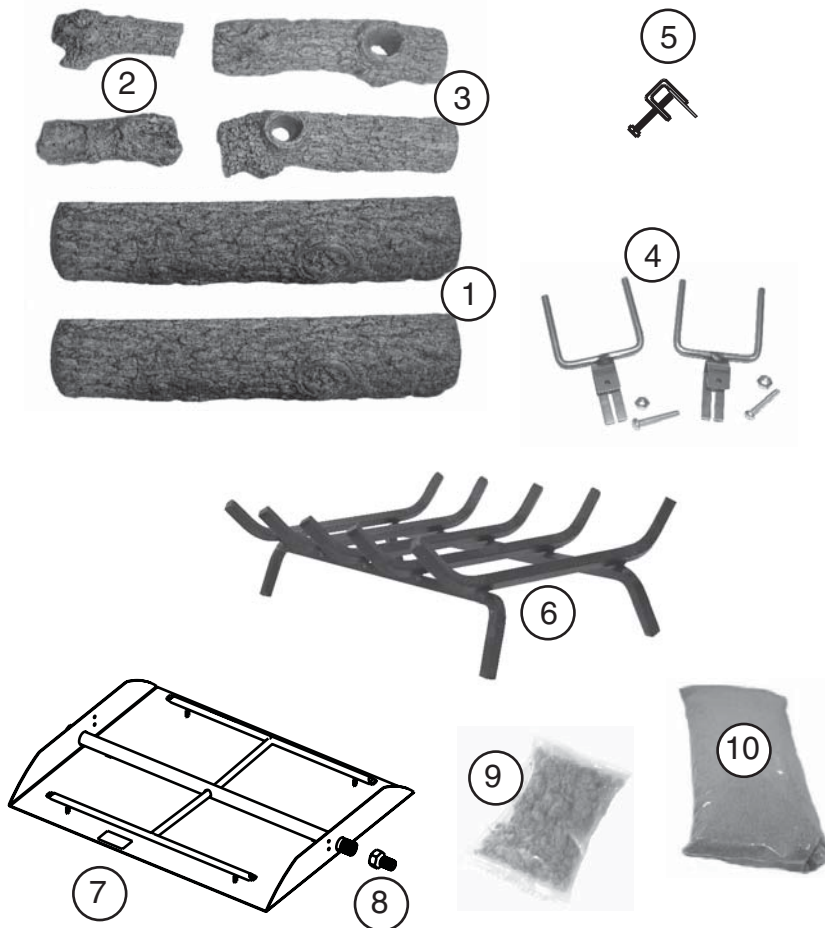

Item No.	Description
1.	Bottom log (2)
2.	Top log (2)
3.	Top log (2)
4.	Log separator (2)
5.	Damper clamp
6.	Fireplace grate
7.	Burner pan
8.	Fuel injector (natural gas) or Air mixer (natural gas)
9.	Glowing embers (2 bags)
10.	Select sand granules (natural gas only) (2) or Vermiculite granules (propane only) (2)
11.	Connector kit (with adapters)

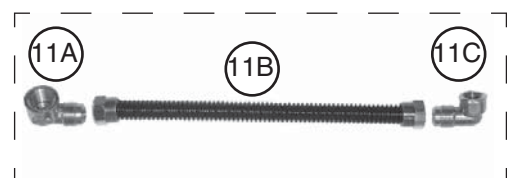

Replacement parts are available through your local Real-Fyre® dealership.

(Drawings not to scale)

IMPORTANT PRE-INSTALLATION AND FIREPLACE SAFETY INFORMATION

CAUTION: Installation and repair must be done by an NFI Certified or other qualified professional installer.

Installer: Carefully read these instructions before installing this gas burner system. Be sure you understand all safety precautions and warnings contained in this manual.

- A. This appliance is designed as an **attended appliance**. Adults must be present when this gas appliance is operating. Do not leave this unit burning when unattended or while anyone is sleeping.
- B. This appliance is only for use with the type of gas indicated on the rating plate. This appliance is **NOT FIELD CONVERTIBLE** for use with other gasses.
- C. **BE CAREFUL: If not installed, serviced, and used correctly per these instructions, this product can cause serious personal injury, property damage, or loss of life.**
- D. **WARNING:** Before installing in a solid-fuel-burning fireplace, **the chimney flue, damper, and firebox must be thoroughly CLEANED** of soot, creosote, ashes, and loose paint, and must be inspected by a qualified chimney cleaner. Some older fireplaces may need repair prior to installing this appliance.
- E. CHECK GAS TYPE (natural or propane): The gas supply must be the same as stated on your burner system rating plate. If gas supply is different, **DO NOT INSTALL**. Contact your dealer for immediate assistance.
- F. Keep the area of the gas burner system clear and free from combustible materials, gasoline, and other flammable vapors and liquids.
- G. INSUFFICIENT GAS PRESSURE WILL KEEP THE PILOT (IF EQUIPPED) FROM OPERATING PROPERLY. DO NOT USE IF GAS PRESSURE IS LOWER THAN THE MINIMUM REQUIREMENT.
- H. The *minimum* inlet gas-supply pressure for purposes of input adjustment is **7"** water column (w.c.) on **natural gas** and **11"** w.c. on **propane gas**. Insufficient gas pressure will affect proper operation of the pilot (if equipped). Do not install this gas appliance if minimum pressure is not available. The *maximum* inlet gas-supply pressure is **10.5"** w.c. on natural gas and **13"** w.c. on propane gas. The propane source must be regulated. (Do not connect this appliance directly to an unregulated propane gas tank - this can cause an explosion.)
- I. The gas piping system must be sized to provide minimum inlet pressure at the maximum flow rate (BTU/hr). Undue pressure loss will occur if the pipe is too small, or the run is too long. Gas supply pipe must be $\frac{1}{2}$ " minimum interior diameter. If the gas line is longer than 20', a larger diameter line may be necessary.
- J. Input ratings shown in BTU per hour are for elevations up to 2,000 ft. For elevations above 2,000 ft., refer to the National Fuel Gas Code or contact manufacturer before installing this product.
- K. This gas appliance and its main gas valve must be disconnected from the gas-supply piping system during any pressure testing of that system at test pressures in excess of $\frac{1}{2}$ psig.
- L. This gas appliance must be isolated from the gas-supply piping system by closing the equipment shutoff valve connected to the gas-supply line during any pressure testing of the gas-supply piping system at test pressures equal to or less than $\frac{1}{2}$ psig.
- M. Do not use this appliance if any part has been underwater. Immediately call a qualified service technician to inspect the appliance and to replace any part of the control system and any gas control that has been underwater.
- N. **A fireplace screen must be in place when the system is burning.** Provisions for adequate combustion air must be maintained. Unless other provisions for combustion air are provided, the screen shall have an opening(s) for introduction of combustion air. Combustion air is adequate when all flames curl into the fireplace and away from the screen. **When a glass fireplace enclosure (door) is used, leave the doors fully open when the system is in operation.**
- O. This appliance may be installed in an aftermarket, permanently located, manufactured (mobile) home, where not prohibited by local codes. Installation of appliances designed for manufactured home (U.S. only) or mobile home installation must conform with the Standard *CAN/CSA Z240 MH, Mobile Housing*, in Canada, or with the *Manufactured Home Construction and Safety Standard, Title 24 CFR, Part 3280*, in the United States, or when such a standard is not applicable, *ANSI/NCSBCS A225.1/NFPA 501A, Manufactured Home Installations Standard*.

INSTALLATION

The damper clamp with hex bolt (Fig. 5-1) is provided as a means to prevent full closure of the damper blade. The clamp is easily attached to most damper blades with pliers or a wrench, and must be permanently installed. The clamp is designed to prevent accidental closure of the damper when installed as illustrated (Fig. 5-2 and Fig. 5-3). Should the clamp not fit, or fail to provide the permanent vent opening listed in the table found above, have a permanent stop installed, remove the damper blade, or have the damper cut to provide the minimum permanent opening required.

Note: These are minimum damper opening specifications. The damper must be completely opened when operating this gas appliance to achieve the best ventilation possible.

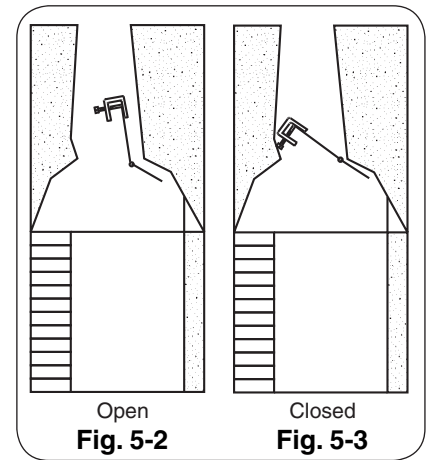
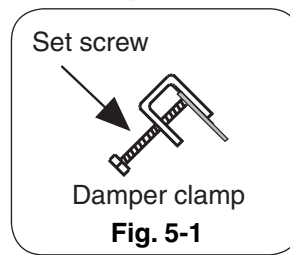

INSTALLING THE BURNER

The Real-Fyre gas log set must be installed by a qualified professional service technician. Instructions must be followed carefully to ensure proper performance and full benefit from the gas log set. **Check to be sure the log set is designed and labeled for the type of gas (natural or propane gas) supplied to the fireplace.** Fireplace floor must be level, clean, and smooth.

WARNING: Failure to position the parts in accordance with these diagrams or failure to use only parts specifically approved with this appliance may result in property damage or personal injury.

REFER TO THE PARTS LIST WHEN FOLLOWING THESE INSTRUCTIONS. **If your burner is to be installed with a pilot kit; carefully follow the instructions supplied with your pilot kit for specific gas connection.**

The burner pan is supplied with an air mixer for propane gas or a fuel injector for natural gas. **The air mixer / fuel injector must be used in ALL installations.** The air mixer / fuel injector has a precisely sized orifice to ensure only the proper quantity of gas enters the burner. This allows maximum performance and gas conservation.

1. MAKE SURE THE FIREPLACE GAS SUPPLY IS TURNED OFF.
2. Locate the gas-supply stub inside the fireplace and remove the cap, if attached (see Fig. 5-4).

CAUTION: When removing the cap, make sure the stub does not turn, loosening the connection inside the wall.

3. Locate the grate (Item 6) and attach the log locators (Item 4) to the 2 outer bars of the grate with screws and nuts. The log locators should be positioned on the middle of the bars with screw slots facing towards fireplace side walls (Fig. 5-5).
4. Attach the small adapter (Item 11C) to the fuel injector / air mixer on the burner pan, using a pipe compound resistant to all gases. Tighten securely. **DO NOT REMOVE THE FUEL INJECTOR / AIR MIXER.** Then attach one end of the flex connector (Item 11B) to the small adapter. Tighten securely.
5. Place the burner pan into the fireplace so that it is centered.

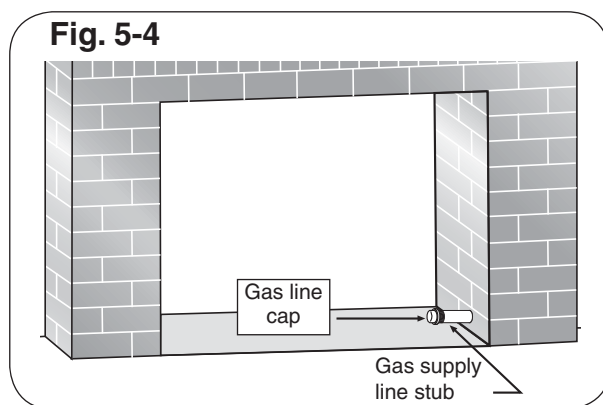

INSTALLATION (cont.)

6. **Be sure gas to the fireplace is off.** Attach the large adapter (Item 11A) to the gas-supply stub using a pipe compound resistant to all gases. Tighten securely. Then attach the open end of the flex connector to the large adapter. Tighten securely. Ensure the pan rests level on the fireplace floor after connection. Adjust the pan if necessary.
7. **LEAK TEST:** Use a long-necked butane lighter, or lay a lighted match next to the burner pipe, and carefully turn on the gas supply until the burner ignites. Test at all connections for leaks using the appropriate soapy water solution. If bubbles appear, a leak is present. Turn off the gas and tighten at all connections. Repeat until no leaks are present. If a leak persists, turn off the gas supply and contact the local gas company or dealer. **NEVER USE A FLAME TO CHECK FOR LEAKS.**

Turn off the gas supply prior to proceeding.

Fig. 6-1 - Fireplace valve

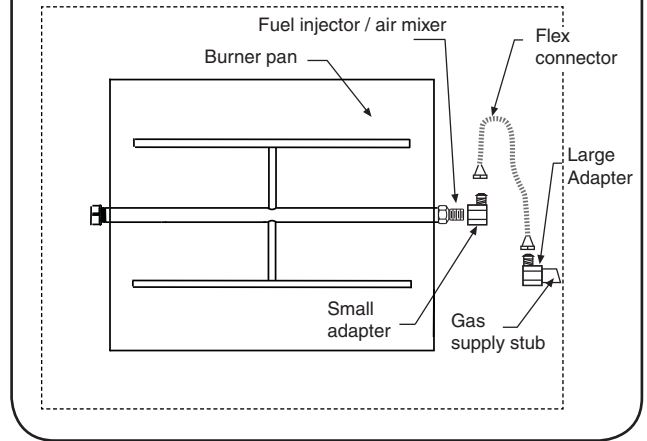

GRANULE, EMBER, AND GRATE PLACEMENT

GRANULE PLACEMENT

The granules supplied with the unit are specially selected for use with either propane gas or natural gas. They maximize flame distribution and reduce carbon buildup.

1. Fill the burner pan completely with the granules* (Item 10). See Fig. 6-2. **Avoid spilling the granules on the pilot kit (if equipped).**

***Note:** Use only select sand for natural gas burners and vermiculite for propane gas burners.

2. Slope the granules at the same angle as the burner pan. This is important to ensure quiet lighting and even flame distribution.

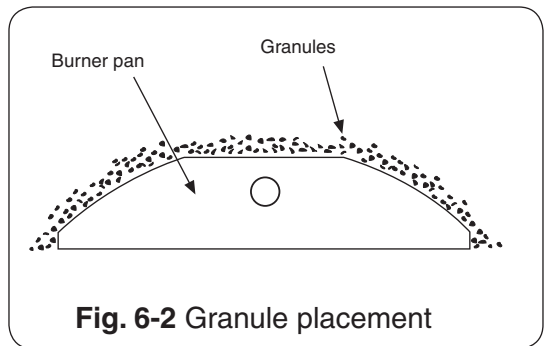

EMBER PLACEMENT

Sprinkle the glowing embers (Item 9) lightly and evenly over the entire surface of the granules. **Break up any clumps that may have developed during shipment.**

Important: Do not add any additional embers to this log set. Any additional embers may cause unsafe operation.

GRATE PLACEMENT

Center the grate over the burner pan.

G45-2-xx-01(M)(P) MODELS ONLY

CONNECTING THE IGNITION PACK TO THE VALVE

The G45-2-xx-01(M)(P) valve comes complete with the wiring harness connected to the pine cone switch. You may wish to ensure it is correctly connected before finally connecting the three wires to the valve, as below.

TO CHECK THE WIRING ASSEMBLY:

- Check that the wiring harness is fitted tightly into the connector on the green ignitor pack in the rear of the pine cone (Fig. 7-1).
- Check that the female connectors on the two black wires from the pilot assembly (wires marked "I" and "S") are inserted fully into the male connectors on the ignitor pack (Fig. 7-2).
- Check the connection of the red and black wires of the wire harness to the respective counterpart wires from the battery holder (red-red and black-black). The two brown wires should be connected to the switch.

Note: The two spare brown wires with coated male connectors are used to connect a remote system (if equipped).

- Connect the wires to the valve in the following order (see Fig. 7-2):

Orange wire marked **THTP** - to **THTP** connector on valve

Black wire marked **TP** - to **TP** connector on valve

Green wire marked **TH** - to **TH** connector on valve

The diagram below shows the wiring layout for the complete unit.

INSTALLING OR REPLACING BATTERIES FOR IGNITION MODULE PACK

Two 1.5-volt (D-cell) alkaline batteries are supplied with the log set. To install or replace batteries, remove the green ignition module pack, held in place with a Velcro strip, from the rear of the pine cone receiver (Fig. 7-3). Remove the battery holder and old batteries from the pine cone. Replace (or install) batteries into the battery holder, making sure they are installed according to the diagram in the battery holder. Replace the ignitor pack and press it firmly into place. The ignition system is now ready to operate.

Note: For the system to work properly, it is suggested that you replace the batteries annually with fresh batteries. Always replace all the batteries at the same time.

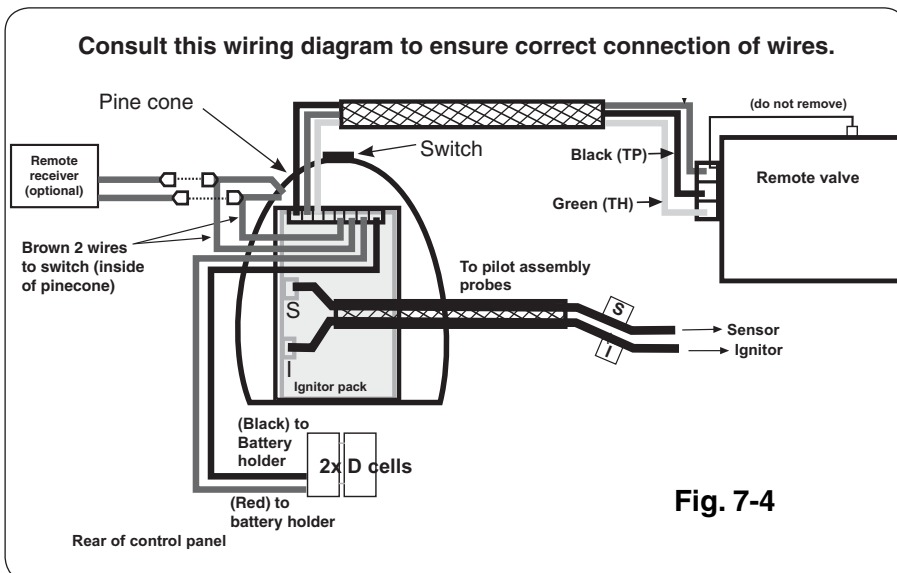
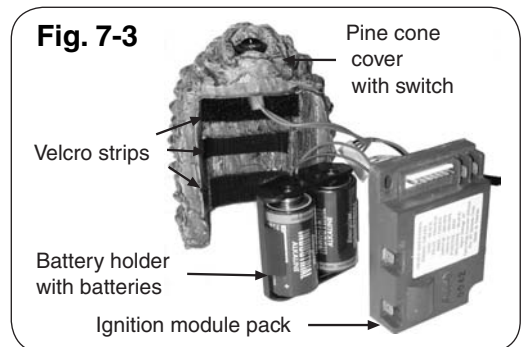
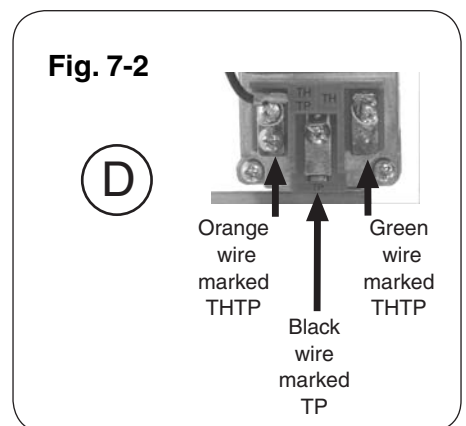
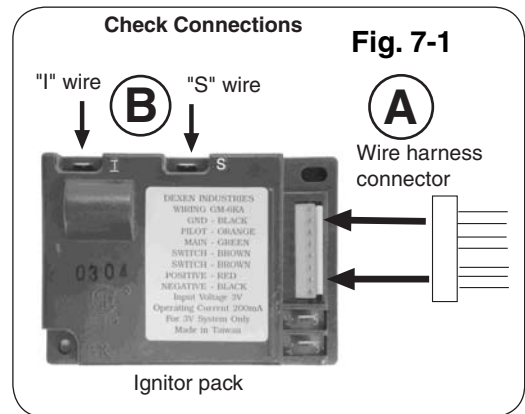

PINE CONE PLACEMENT

The designer pine cone incorporating the control switch is aesthetically designed and is an integral part of the operation of the log set. Place the pine cone a minimum of 6" from the burner/flame. If the pine cone is in the firebox, the rear of the pine cone must not be exposed to the flame, but towards the right firebox wall.

CAUTION: THE PINE CONE MAY BE HOT DURING AND DIRECTLY AFTER OPERATION OF THE GAS LOG SET.

LOG PLACEMENT

1. **Log placement is very important for the proper operation and performance of the Real-Fyre® gas log set.** Although you have some flexibility in the log arrangement, it is necessary to follow the log placement instructions carefully to fully enjoy the log set.
2. Place the bottom logs on the grate. The log locators ensure that adequate space between the logs is maintained for a clean burn (Fig. 8-1).
3. Place the middle/top logs diagonally with space between the logs so that the flames are not choked off. Adjust the middle/top logs until desired look, and flame pattern are achieved. Flexibility is possible provided excessive sooting does not result from flames striking the logs too directly. Reference Fig. 8-2 for some examples.

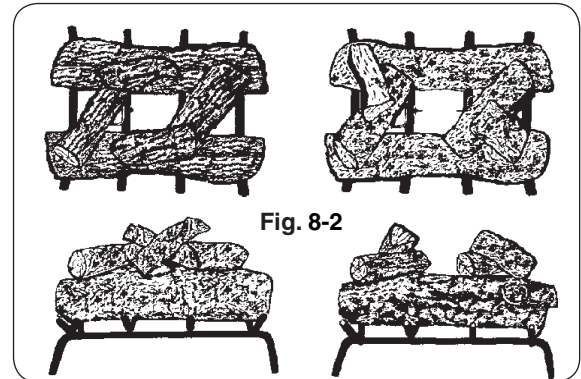
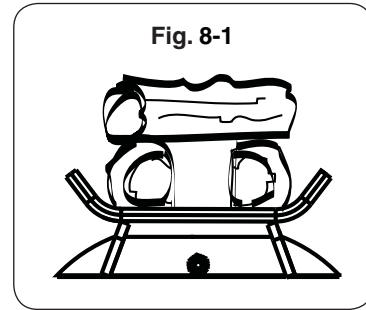

Styles and sizes will vary depending upon the log set ordered. If the log set ordered includes placement instructions; follow those instructions.

CAUTION: Burn hazard. Logs will remain hot for some time after use. You must maintain the log layout as shown to ensure proper operation of your log set. If you need to reposition any log to maintain the proper layout, use heat-resistant gloves or allow logs adequate time to cool before handling.

LIGHTING INSTRUCTIONS - MANUAL VALVE

Before operating your gas log set:

1. Be sure your fireplace is free from flammable liquids or combustible materials.
2. Be sure your damper is open.
3. Smell all around the gas log set for the odor of escaping gas. IF YOU SMELL GAS, FOLLOW THE INSTRUCTIONS ON P. 1.

If your gas log set is operated by the fireplace valve:

1. Lay a lighted long-stem match on the surface of the embers near the gas inlet (**do not hold the match in your hand**) or use a lighted long-necked butane lighter (Fig. 9-1).
2. Slowly turn the fireplace remote valve to the **ON** position. Your log set should light.
3. If the log set does not light before the match goes out, immediately turn the valve to the **OFF** position.
4. Wait approximately five (5) minutes to clear out any gas, and repeat steps 1-3 above.
5. If your log set fails to light again, turn the valve to the **OFF** position and contact your dealer or gas supplier.
6. **To extinguish your gas log set**, turn the valve to the **OFF** position. Be sure the valve is turned fully off to avoid any gas leakage.

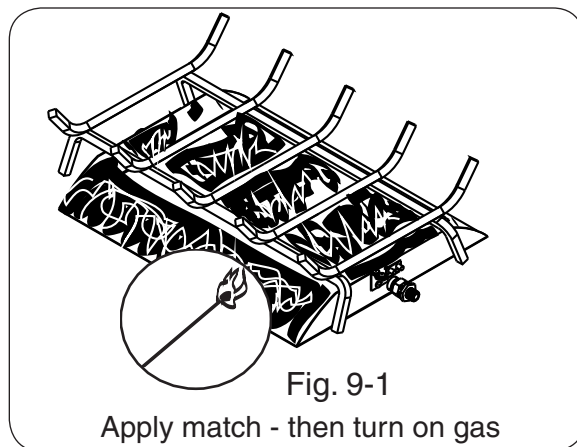

If your burner is operated by a pilot kit:

1. Carefully follow the lighting instructions supplied with your pilot kit for the steps to ignite the burner.

EXAMPLE LOG PLACEMENTS

GOLDEN OAK

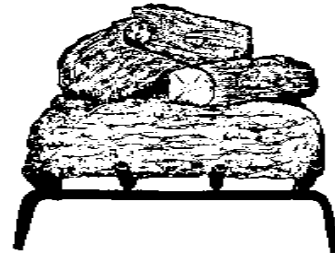
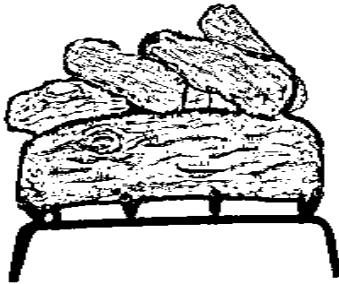
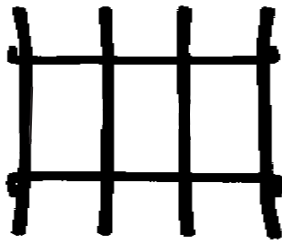
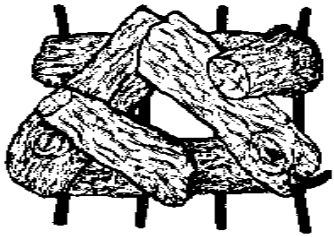

GOLDEN OAK

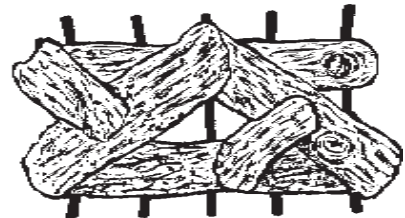
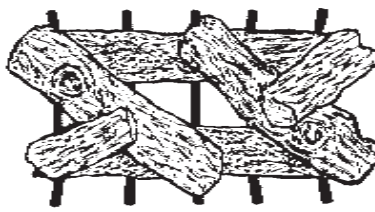
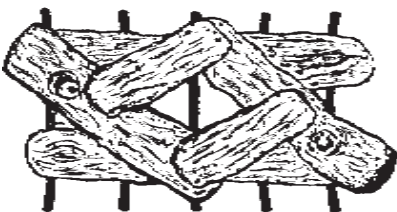

GOLDEN OAK

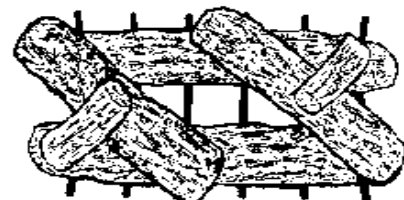
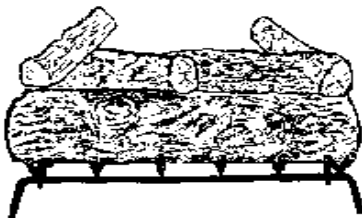
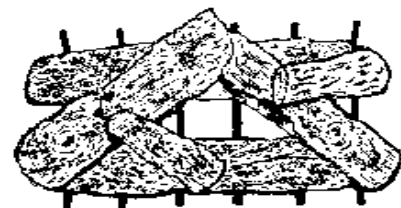
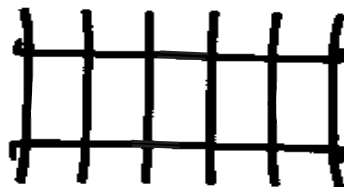
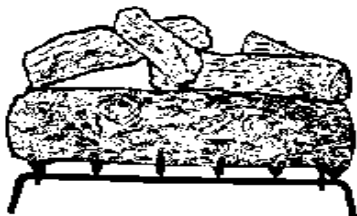
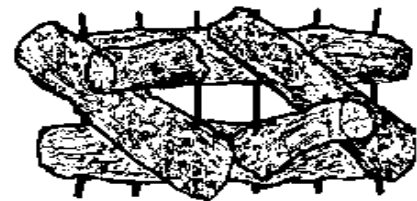
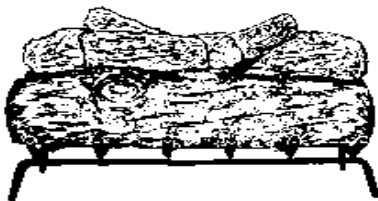

EXAMPLE LOG PLACEMENTS

SPLIT LOG

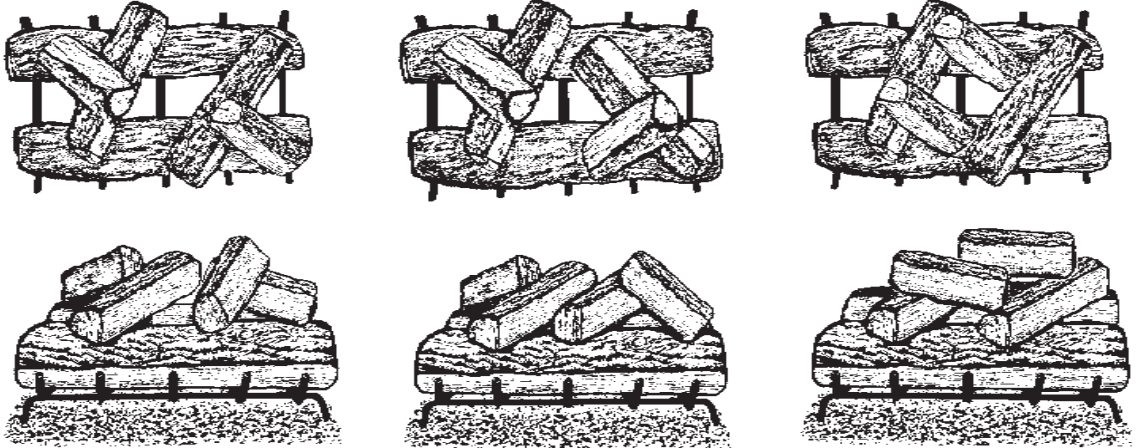

SPLIT LOG

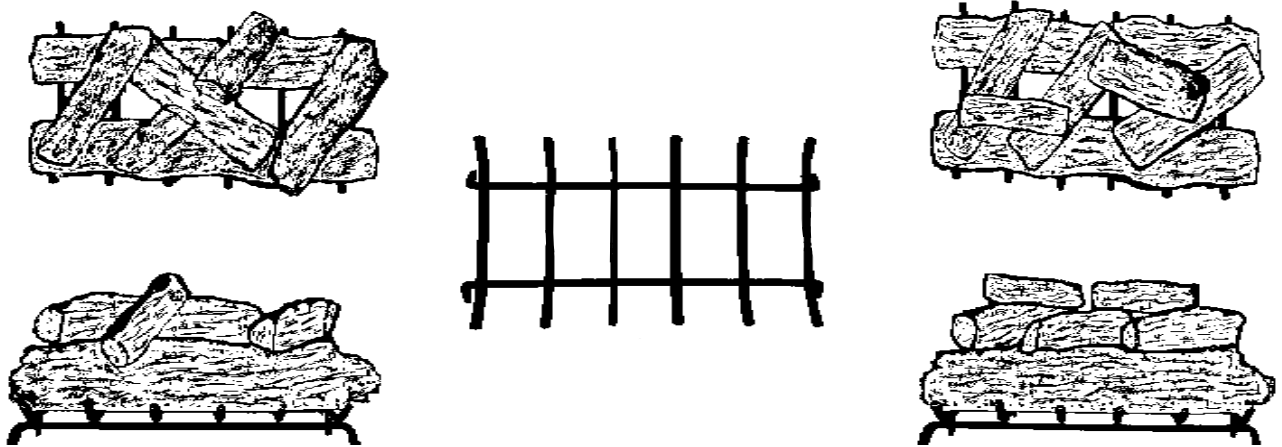

DRIFTWOOD

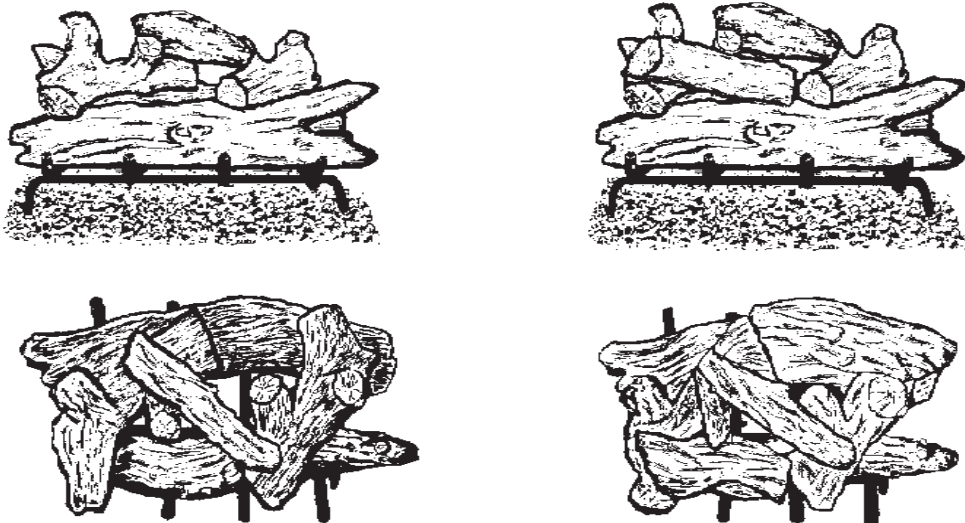

TROUBLESHOOTING YOUR GAS LOG SET

SYMPTOM	CAUSE	SOLUTION
1. Excessive smoking and sooting	A. Poor draft or downdraft	A. Check for chimney blockage. Be sure chimney is at least 3' taller than anything within 10' of it in all directions. If not, consult a chimney sweep. Chimney cap or fan may help. Under severe conditions, you may need to open a window near the fireplace about 1" to 2" when burning the log set.
	B. Improper burner for gas used	B. Use only a natural-gas set with natural gas. Use only a propane-gas set with propane gas.
	C. Damper closed	C. Open the damper fully when operating the gas log set.
	D. Improper log placement	D. Be sure the bottom logs are spaced at least 3" apart. Top logs should be placed to minimize flame impingement.
	E. Air mixer on propane set is closed	E. Open the air mixer completely.
2. Low flame	A. Incorrect log set for type of gas used	A. Consult your dealer for proper set.
	B. Insufficient gas supply	B. Other gas appliances may be competing for gas supply. Consult installer or plumber. Orifice size is based upon 7" w.c. pressure for natural gas and 11" w.c. pressure for propane gas. Plumbing must supply adequate pressure.
	C. Blockage or kink in connector kit, plumbing, or burner orifice	C. Clean out blockage. If connector kit is kinked, replace it.
	D. Valve not fully open	D. Open valve fully.

TROUBLESHOOTING YOUR GAS LOG SET (Cont.)

SYMPTOM	CAUSE	SOLUTION
3. Uneven flame distribution (Lower at one end of the burner)	A. Clogged or blocked portholes	A. Portholes can be cleared of foreign object by running a wire through them.
	B. Insufficient gas pressure and/or supply	B. Consult installer or plumber. (See solution 2b.)
	C. Granules may be packed down too tightly	C. Loosen granules around burner pipe by running a kitchen knife along both sides of pipe. Even out granules in burner pan.
	D. Auxiliary shutoff valve partially closed	D. Open valve fully. Usually, you will find this along the wall 3' from the fireplace.
4. Flame at air mixer (For propane units)	A. Clogged or blocked portholes	A. Portholes can be cleared of foreign object by running a wire through them.
	B. Insufficient gas pressure and/or supply	B. Consult installer or plumber. (See solution 2b.)
	C. Granules may be packed down too tightly	C. Loosen granules around the burner by running a kitchen knife along both sides of the pipe. Be sure vermiculite (not sand) is used with an air mixer.
	D. Excessive gas pressure	D. Contact your gas supplier.

WARRANTY

PETERSON VENTED GAS LOG SETS LIMITED WARRANTY

All Peterson gas logs are **WARRANTED for as long as you own them (lifetime)**.

All Peterson burner assemblies are **WARRANTED for TEN (10) YEARS**.

SPK-26 controls are covered by a **THREE (3) YEAR "All Parts" Warranty**.

All other Peterson valves, pilots, and controls are covered by a **ONE (1) YEAR Limited Warranty (excluding batteries)**.

PLEASE KEEP A COPY OF YOUR SALES SLIP FOR PROOF OF PURCHASE

This warranty applies to the original purchaser and to single family residential use only. It commences from date of purchase, and is valid only with proof of purchase.

This warranty does not cover parts becoming defective through misuse, accidental damage, electrical damage, improper handling, storage, and/or installation. Product must be installed (and gas must be connected) as specified in the instructions or operator's manual, by a **qualified professional installer**. Accessories, parts, valves, remotes, etc., when used must be Peterson Co. product.

This warranty **does not** apply to rust, corrosion, oxidation, or discoloration, unless the affected component becomes inoperable. It **does not** cover labor or labor-related charges.

This warranty specifically excludes liability for **indirect, incidental**, or consequential damages. Some states do not allow the exclusion or limitation of incidental or consequential damages, so the above exclusion may not apply to you. This warranty gives you specified legal rights, and you may have other rights that may vary from state to state.

For additional information regarding this warranty, or to place a warranty claim, contact the R.H. Peterson dealer where the product was purchased.

**TO REGISTER YOUR PRODUCT ONLINE GO TO: WWW.RHPETERSON.COM,
AND CLICK ON PRODUCT REGISTRATION. THANK YOU FOR YOUR PURCHASE.**