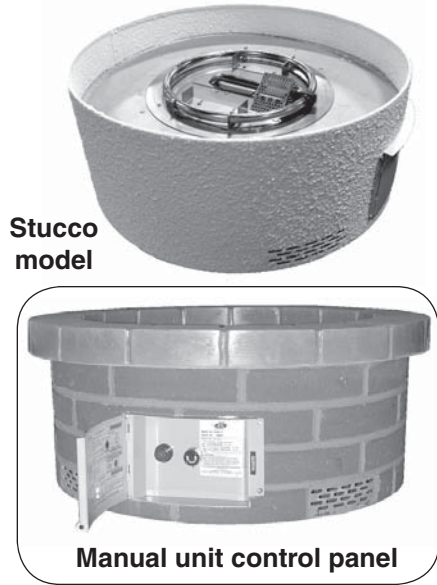


RH PETERSON co.  
**MANUAL & REMOTE-OPERATED  
 OUTDOOR CAMPFYRE™**

**OWNER'S  
 MANUAL**



Stucco model

Manual unit control panel



**FOR OUTDOOR USE ONLY**

Remote control



Remote unit control panel  
 (behind door)

**For OCR-27 Series Outdoor Campfyres™**

**CODE AND SUPPLY REQUIREMENTS:**

This Outdoor Campfyre™ must be installed in accordance with local codes and ordinances, or, in the absence of local codes, with the latest *National Fuel Gas Code, ANSI Z223.1*.

**FOR YOUR SAFETY, IF YOU SMELL GAS:**

1. Shut off the gas to the appliance.
2. Extinguish any open flame.
3. If odor continues, immediately call the gas supplier or the fire department.

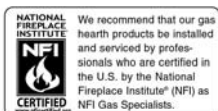
**FOR YOUR SAFETY**

1. Do not store or use gasoline or other flammable vapors and liquids in the vicinity of this or any other appliance.
2. A propane cylinder not connected for use shall not be stored in the vicinity of this or any other appliance.

**Installation and service must be performed by an NFI Certified or other qualified professional installer, service agency, or the gas supplier.**

**INSTALLER & CONSUMER**

**These instructions MUST be retained with this appliance for future reference.**



We recommend that our gas hearth products be installed and serviced by professionals who are certified in the U.S. by the National Fireplace Institute® (NFI) as NFI Gas Specialists.

**Certified to:**  
 ANSI Z21.97-2010 for outdoor decorative gas appliances  
 CAN1-2.21 - M85 for outdoor installation of gas-fired appliances



**09-66**

**Important:** Read these instructions carefully before starting installation of the Outdoor Campfyre™.

**WARNING**

Improper installation, adjustment, alteration, service, or maintenance can cause property damage, personal injury, or loss of life. Refer to this manual. For assistance or additional information, consult a qualified professional installer, service agency, or the gas supplier.

This appliance is designed as an **attended appliance**. Adults **must** be present when the unit is operating. **DO NOT** leave this unit burning when unattended. If this product is left burning unattended, it may cause damage or serious injury.

**IMPORTANT**

For safe operation and proper performance of this product and to comply with certification, listings, and building code acceptances, use **ONLY** Peterson Real-Fyre® controls, parts, and accessories that have been specifically listed or certified for use with this burner system. Use of other controls, parts, or accessories is prohibited and will void all warranties, certifications, listings, and building code approvals, and may cause property damage, personal injury, and loss of life.

RH PETERSON co.  
**CAMPFYRE DE PLEIN AIR™**  
**OPÉRÉ ÉLOIGNÉ**

**OWNER'S  
MANUAL**



modele  
du stuc



Manuel de commande



télécommande



Le Panneau de commande  
(derrière porte)

**Pour toute l'OCR-27 série Campfyres extérieur**

**POUR USAGE DE PLEIN AIR  
SEULEMENT**

**IMPORTANT: LISEZ AVEC SOIN CE MANUEL  
AVANT INSTALLATION INITIALE  
DE VOTRE CAMPFYRE DE PLEIN AIR™.**

**POUR VOTRE SÉCURITÉ SI VOUS  
SENTEZ DU GAZ:**

1. Fermer le gaz à l'appareil.
2. Éteignez toute flamme ouverte.
3. Si l'odeur continue, immédiatement appelez votre fournisseur du gaz ou Sapeur-pompier.

**POUR TA SÉCURITÉ**

1. N'entreposez pas ou utilisez dans les environs de l'essence ou autres vapeurs inflammables et liquides de ce ou tout autre appareil.
2. Un propane le cylindre ne branché pas pour usage ne sera pas entreposé dans les environs de ce ou tout autre appareil.

L'installation et service doivent être exécutés par un NFI Certified ou autre installateur qualifié, professionnel, agence du service ou le fournisseur du gaz.



**CODE ET EXIGENCES DE LA PROVISION:**

Ce Campfyre De plein air doit être installé conformément à codes locaux et ordonnances, ou dans l'absence de codes locaux, avec le Code du Gaz du Combustible National le plus tardif, ANSI Z223.1.

**PRÉVENIR:**

L'installation abusive, ajustement, altération, service ou maintien peut causer blessure ou avarie de la propriété. Faites référence à ce manuel. Pour assistance ou information supplémentaire l'installateur qualifié, agence du service ou fournisseur du gaz consultant.

Cet appareil est conçu comme un. a assisté à appareil. les Adultes doivent être présents quand l'unité opère. Ne laissez pas cette unité qui brûle quand sans assistance. Si ce produit est laissé brûler sans assistance il peut causer avarie ou blessure sérieuse.

**INSTALLATEUR & CONSOMMATEUR:** Ces directives doivent être retenues avec cet appareil.



**Certifié à: ANSI Z21.97-2010 pour les appareils à gaz décoratifs extérieurs  
CAN1-2.21 - M85 pour l'installation extérieure des appareils à gaz**

## TABLE OF CONTENTS

|    |  |
|----|--|
| 4  | MANUAL MODEL PARTS LIST AND LOCATIONS              |
| 5  | REMOTE MODEL PARTS LIST AND LOCATIONS              |
| 6  | PRE-INSTALLATION AND PREPARATION SAFETY GUIDELINES |
| 7  | INSTALLATION SAFETY GUIDELINES                     |
| 7  | OPERATING THE UNIT SAFELY AND CORRECTLY            |
| 9  | SAFE USE & MAINTENANCE OF PROPANE GAS CYLINDERS    |
| 10 | CONNECTING THE GAS TO THE OUTDOOR CAMPFYRE™        |
| 10 | MINIMUM CLEARANCE TO COMBUSTIBLES                  |
| 11 | ALTERNATE GAS INSTALLS THROUGH SIDEWALL            |
| 13 | INSTALLATION OF THE OUTDOOR CAMPFYRE™ RING         |
| 13 | CAMPFYRE™ RING PLACEMENT                           |
| 14 | CONVERTING TO A DIFFERENT GAS TYPE                 |
| 15 | DECORATIVE MEDIA OPTIONS                           |
| 15 | OPTIONAL CAMPFYRE LOGS                             |
| 17 | OPTIONAL BEACHWOOD LOGS AND/OR VOLCANIC STONE      |
| 19 | OPTIONAL GLASS/GEMS OR RIVER ROCK ON GLASS/GEMS    |
| 20 | NOTES PAGE   |
| 21 | 01 VALVE SERIES LIGHTING INSTRUCTIONS              |
| 23 | MANUAL (PIEZO) LIGHTING INSTRUCTIONS               |
| 25 | OPERATION  |
| 25 | CLEANING & MAINTENANCE                             |
| 26 | PETERSON CAMPFYRE LIMITED WARRANTY                 |

# MANUAL MODEL PARTS LIST AND LOCATIONS

Fig. 4-1



Fig. 4-2

| NO. | DESCRIPTION                                 |
|-----|---|
| 1.  | Burner tube                                 |
| 2.  | Burner pan                                  |
| 3.  | Igniter assembly (thermocouple)             |
| 4.  | Screen, burner                              |
| 5.  | Valve assembly                              |
| 6.  | Propane-gas orifice (*not shown)            |
| 7.  | Lava granules (10 lbs) & lava coals (6 lbs) |

3 Fig. 4-3

### Igniter assembly (under screen)

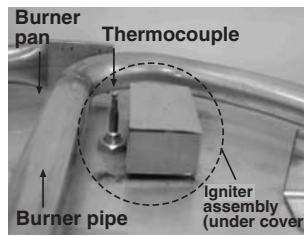
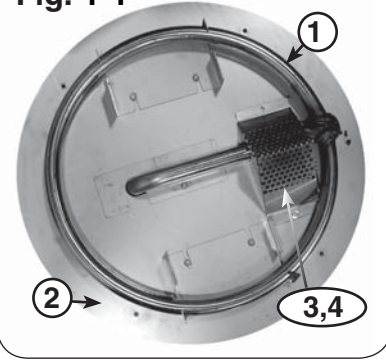


Fig. 4-4



### 9 Lava granules & coals

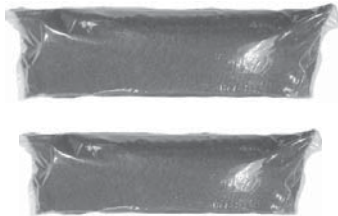


Fig. 4-5

### Control panel assembly

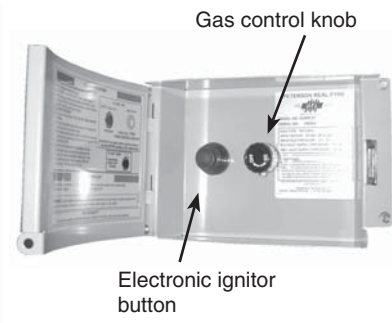
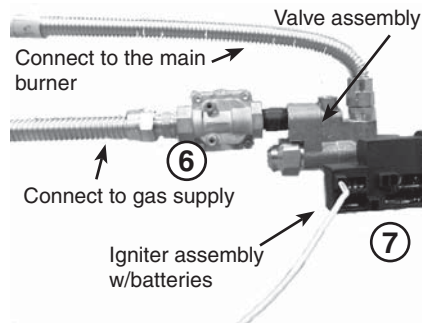
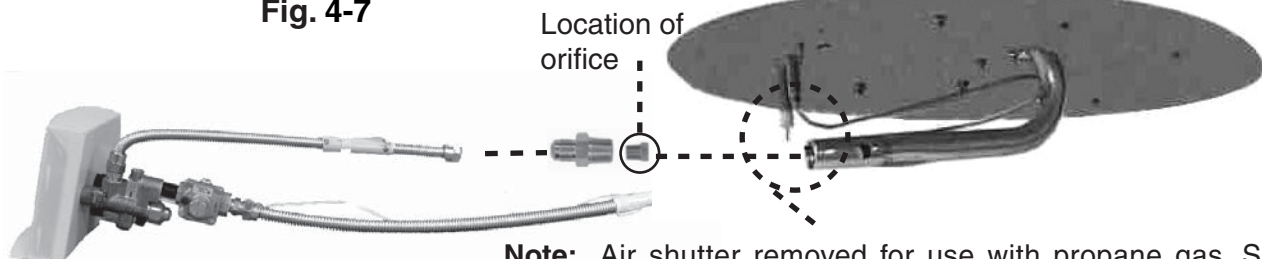


Fig. 4-6

### Control panel assembly

### Burner plate assembly

Fig. 4-7



**Note:** Air shutter removed for use with propane gas. See the CONVERTING THE MANUAL VALVE OUTDOOR CAMPFYRE™ TO A DIFFERENT GAS TYPE section.

**Note:** When converting the Outdoor Campfyre™ to another gas type, detach the thermocouple and the ignitor wire. (See instructions supplied with the replacement kit.)

# REMOTE MODEL PARTS LIST AND LOCATIONS

Fig. 5-1



Control panel assembly  
( removed for photo)

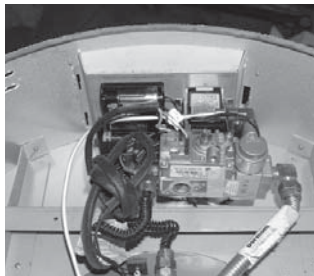
Fig. 5-2



Control panel  
securing points

Front

Fig. 5-3



Rear (inverted) ④

**NO. DESCRIPTION**

1. Burner pan assembly
2. Pilot assembly (screen removed for visibility only)
3. Fire pit
4. Control panel assembly
5. Lava granules (10 lbs) & lava coals (6 lbs)
6. Remote handset
7. Gas-type orifice (\*not shown; located under pan assembly)

①



Fig. 5-4

Fig. 5-5

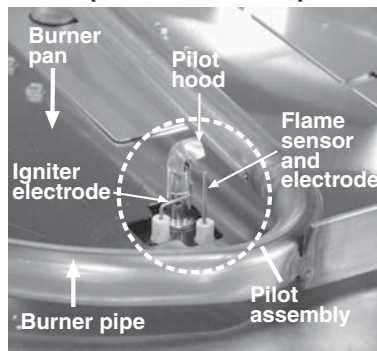


①

②

Pilot assembly  
(under screen)

Fig. 5-6



⑤

Lava granules  
& coals

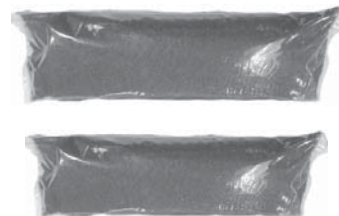
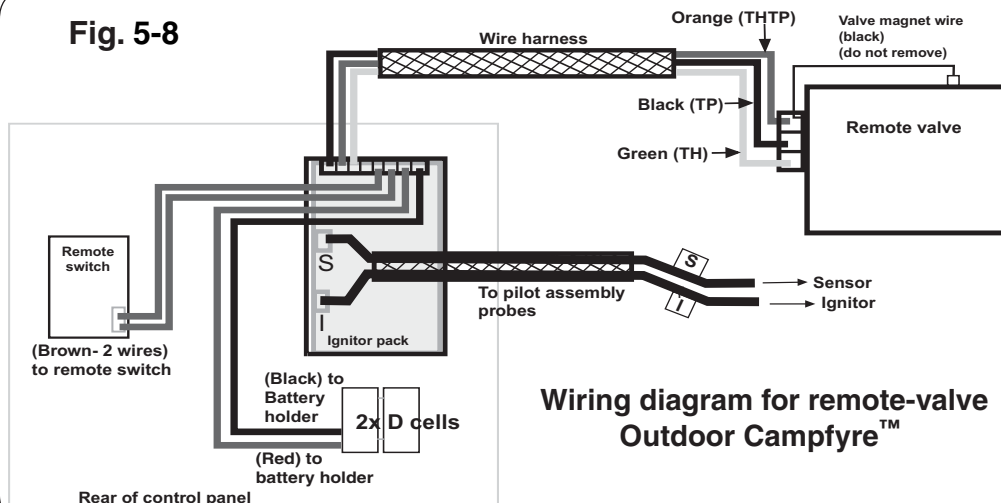


Fig. 5-7

Fig. 5-8



Remote handset

⑥

Control  
buttons



Fig. 5-9

## PRE-INSTALLATION AND PREPARATION SAFETY GUIDELINES

- A. Before installing this unit, check the MINIMUM CLEARANCE TO COMBUSTIBLES section to ensure that the surrounding area is **properly sized for the installation**.
- B. The unit is for outdoor use only. **DO NOT** install or use this appliance inside a building, garage, or any other enclosed area, including recreational vehicles and/or boats. **This unit must be installed in such a manner that the vent opening at the base of the unit remains clear and free of all obstructions at all times and during all weather conditions.**
- C. **CHECK GAS TYPE** (natural gas or propane): The gas supply you intend to use may not be the same as that stated on the unit rating plate as purchased. If the gas supply is different, **convert the unit to the gas type you intend to use**. See the CONVERTING TO A DIFFERENT GAS TYPE SECTION. If you are unsure, contact the dealer for assistance. **ONLY MANUAL UNITS ARE CONVERTIBLE**.
- D. **FOR NATURAL GAS:** The minimum inlet gas-supply pressure for purposes of input adjustment is **5"** water column (w.c.), and the maximum inlet gas-supply pressure is **10.5 "** w.c. **FOR PROPANE:** The minimum inlet gas-supply pressure for purposes of input adjustment is **8"** w.c., and the maximum inlet gas-supply pressure is **13"** w.c. **DO NOT INSTALL THIS UNIT IF MINIMUM PRESSURE IS NOT AVAILABLE OR IF MAXIMUM PRESSURE IS EXCEEDED.**
- E. Gas piping system must be sized to provide minimum inlet pressure at the maximum flow rate (BTU/hr). Undue pressure loss will occur if the pipe is too small, or the run is too long.
- F. For installations at elevations above 2,000 ft., contact your local dealer or gas supplier before installing. Input ratings should be reduced approximately 4% for each 1,000 ft. above sea level. Refer to the National Fuel Gas Code.
- G. The unit and its individual shutoff valve must be disconnected from the gas-supply piping system during any pressure testing of that system at test pressures in excess of 1/2 psi (3.5 kPa). This is accomplished by closing the gas-supply line valve. The unit must be isolated from the gas-supply piping system by closing its individual manual shutoff valve during any pressure testing of the gas-supply piping system at test pressures equal to or less than 1/2 psi (3.5 kPa).
- H. **INSTALLER NOTE:** This unit should be installed so that it can be removed if service is required.

### I. GAS-SUPPLY PLUMBING REQUIREMENTS

Apply only joint compounds that are resistant to all gasses on all male pipe fittings. Make sure to tighten every joint securely. Do not use pipe joint compound to connect flare fittings. Bring the gas-supply pipe up from beneath the enclosure near its center (if applicable).

**CAUTION:** Installation and maintenance must be done by an NFI Certified or other qualified professional installer. Installer, read these instructions before installing this product. Be sure you understand all safety precautions and warnings contained in this manual.

**Note:** An external on/off valve in the gas line is required for safety when the unit is not in use. It also provides for convenient maintenance and repair.

## INSTALLATION SAFETY GUIDELINES

- A. Installation and repair should be done by a qualified service person. The appliance should be inspected before use and at least annually by a qualified service person. More frequent cleaning may be required as necessary. It is imperative that control compartment, burners and circulating air passageways of the appliance be kept clean.
- B. Carefully inspect for shipping damage. If any parts are damaged, call the dealer.
- C. Correct installation and proper placement of the unit and decorative media is crucial to the safe performance of the unit. See installation instructions for further information. **NEVER COVER THE BURNER SCREEN WITH DECORATIVE MEDIA OR ANY OTHER ITEM. THIS WILL IMPAIR ITS EFFICIENCY AND CAUSE THE UNIT TO MALFUNCTION.**
- D. Ensure that the unit is installed in such a manner that the vent opening at the base of the unit remains obstacle-free at all times and during all weather conditions.
- E. Due to high temperatures, the unit must be located out of traffic areas and away from combustibles.

## OPERATING THE UNIT SAFELY AND CORRECTLY

- A. **This appliance is only intended for operation in temperatures above 32°F.**
- B. When shutting the unit down—be sure to TURN THE CONTROL VALVE FULLY OFF.
- C. Children MUST be carefully supervised when they are in the area of this appliance.
- D. DO NOT sit or place any part of the body, clothing, or other flammable materials on or near the unit surround. Children and adults should be alerted to the hazard of high surface temperatures and should stay away to avoid burns or clothing ignition.
- E. Every time you use the unit, make sure that:
  - 1. The area around the unit is clear and free from combustible materials, gasoline and other flammable vapors and liquids.
  - 2. There is no blockage of the airflow through the vent openings located on the bottom of the unit.
  - 3. **THE SCREEN IS NOT COVERED OR BLOCKED WITH DECORATIVE MEDIA OR ANY OTHER ITEM.**
- F. **WARNING: HOT WHILE IN OPERATION AND FOLLOWING OPERATION.** Serious injury can occur! **DO NOT** throw trash, paper, or other flammable materials onto the unit. **DO NOT** leave in operation when unattended.  
**WARNING: DO NOT operate this unit in the rain.**
- G. SOLID FUEL MUST NOT BE BURNED in the unit.
- H. **DO NOT** continue using if you smell unusual odors, or have headaches, nausea, or dizziness.
- I. **DO NOT** store any combustible materials, gasoline, and any other flammable vapors/liquids in the vicinity of the unit. Provide adequate clearance for servicing and operation.
- J. Matches, paper, garbage, or any other material must not be thrown onto the unit or into the flame.
- K. **DO NOT** use the unit if any part of it has been underwater. Immediately call a qualified professional service technician to inspect the set and to replace any part of the control system that has been underwater.

# UTILISATION SÛRE ET ENTRETIEN DES CYLINDRES DE GAZ DE PROPANE

## IMPORTANT POUR VOTRE SÛRETÉ

LISEZ ET SUIVEZ TOUS LES AVERTISSEMENTS ÉQUIPÉS DE VOTRE CYLINDRE DE GAZ DE PROPANE.

En actionnant cet appareil avec un cylindre de gaz de propane ON DOIT observer ces instructions et avertissements.

**LE MANQUE DE FAIRE AINSI PEUT AVOIR COMME CONSÉQUENCE UNE INCENDIE OU UNE EXPLOSION SÉRIEUSE.**

### CYLINDRE ET CONDITIONS ET

#### CARACTÉRISTIQUES DE CONNECTEUR

- Des cylindres et les valves de gaz de propane doivent être maintenus en bon état et doivent être remplacés s'il y a des dommages évidents au cylindre ou à la valve.
- Ce gril, une fois utilisé avec un cylindre, devrait être relié à un gallon de la norme 5 (20lb.) cylindre de gaz de propane équipé d'un OPD (remplissez au-dessus du niveau le dispositif d'empêchement). L'OPD a été exigé sur tous les cylindres vendus depuis octobre 1.1998 pour empêcher le remplissage excessif.
- Les dimensions de cylindre devraient être approximativement 12" (30.5cm) de diamètre et 18" (45.7cm) hauts. Des cylindres doivent être construits et marqués selon les caractéristiques pour des cylindres de gaz de propane du département des ETATS-UNIS du transport (D.O.T.) ou le niveau national du Canada, du CAN/CSA-B339, des cylindres, des sphères et des tubes pour le transport des marchandises dangereuses.
- Le cylindre doit inclure un collier pour protéger la valve de cylindre et le circuit d'alimentation de cylindre doit être assuré le retrait de vapeur.
- Le régulateur de pression et l'ensemble de tuyau (fig. 8-1) fourni avec cet appareil à cuire extérieur de gaz doivent être utilisés. Les régulateurs d'original et de pression de remplacement et les ensembles de tuyau doivent être ceux indiqués par le fabricant pour le raccordement avec un dispositif se reliant de cylindre identifié comme type I par la norme ANSI Z 21.58-2007/CGA 1.6-2007 avec la norme ANSI Z 21.58a -1998 d'addenda et CGA 1.6a - M98.
- La valve de cylindre de gaz de propane doit être équipée d'un dispositif d'accouplement de raccordement de cylindre, décrit comme type I dans la norme définie dans le e. de paragraphe ci-dessus. Ce dispositif est généralement décrit comme coupleur rapide de fil de point culminant.
- Si votre cylindre de gaz de propane vient avec une prise de la poussière, placez le bouchon anti-poussière sur la sortie de valve de cylindre toutes les fois que le cylindre n'est pas en service.

#### OPÉRATION DE COUPLEUR RAPIDE

**Pour relier le régulateur/hose à l'ajustage de précision de valve de cylindre de gaz de propane:** Serrez l'écrou de main sur le régulateur au-dessus de l'ajustage de précision de fil de point culminant sur la valve de cylindre. Tournez l'écrou de

main dans le sens des aiguilles d'une montre pour engager les fils et pour serrer jusqu'à ce que douillettement. L'utilisation des pinces ou de la clé ne devrait pas être nécessaire. Seulement le propane marqué par cylindres doit être employé.

**Pour débrancher:** Tournez l'écrou de main dans le sens contraire des aiguilles d'une montre jusqu'à isolé (fig. 8-1).

**Important:** Avant d'employer le gril, et ensuite chaque fois que le cylindre est enlevé et rattaché, examinez tous les raccordements pour déceler les fuites. Arrêtez les valves de gril et ouvrez la valve principale de cylindre, puis vérifiez les raccordements avec de l'eau savonneux. Réparez toutes les fuites avant d'allumer le gril.

**ATTENTION:** Tournez toujours la valve principale de cylindre de propane au loin après chaque utilisation, et avant de déplacer le gril et le cylindre, ou débrancher l'accouplement. Cette valve doit rester fermée et le cylindre a débranché alors que l'appareil n'est pas en service, quoique l'écoulement de gaz soit arrêté par un dispositif de sûreté quand le coupleur est débranché.

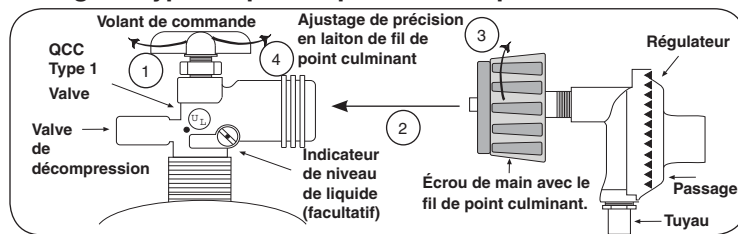
**Inspectez soigneusement** l'ensemble de tuyau chaque fois avant que le gaz soit allumé. Un tuyau criqué ou frangé devrait être remplacé immédiatement.

Si l'appareil est stocké à l'intérieur, le cylindre doit être disconnected et a enlevé. Des cylindres Disconnected doivent être stockés dehors, hors de la portée des enfants, avec les prises de valve filettées étroitement installées, et ne doivent pas être stockés dans un bâtiment, le garage, ou n'importe quel autre secteur inclus.

#### POUR VOTRE SÛRETÉ

- Ne stockez pas un cylindre de gaz disponible de propane dessous ou ne vous approchez pas de cet appareil.
- Ne remplissez jamais cylindre au delà de 80 pour cent de plein.
- SI L'INFORMATION DANS "A" ET "B" N'EST PAS SUIVIE EXACTEMENT, UN FEU CAUSANT LA MORT OU DES DOMMAGES SÉRIEUX PEUT SE PRODUIRE.

Fig. 8-1 type coupleur rapide de fil de point culminant d'I



# SAFE USE & MAINTENANCE OF PROPANE GAS CYLINDERS

## IMPORTANT FOR YOUR SAFETY

### READ AND FOLLOW ALL WARNINGS PROVIDED WITH THE PROPANE-GAS CYLINDER.

When operating this appliance with a propane-gas cylinder, these instructions and warnings **MUST** be observed.

**FAILURE TO DO SO MAY RESULT IN A SERIOUS FIRE OR EXPLOSION.**

## CYLINDER/CONNECTOR REQUIREMENTS

- a. Propane-gas cylinders, valves, and hoses must be maintained in good condition and must be replaced if there is visible damage to either the cylinder or valve. If the hose is cut or shows excessive abrasion or wear, it must be replaced before using the gas appliance (see e.).
- b. This unit, when used with a cylinder, should be connected to a standard 5-gallon (20 lb.) propane-gas cylinder equipped with an OPD (Overfill Prevention Device). The OPD has been required on all cylinders sold since October 1, 1998, to prevent overfilling.
- c. Cylinder dimensions should be approximately 12" (30.5 cm) in diameter and 18" (45.7 cm) high. Cylinders must be constructed and marked in accordance with the *Specifications for Propane Gas Cylinders of the U.S. Department of Transportation (D.O.T.)* or the National Standard of Canada, *CAN/CSA-B339, Cylinders, Spheres, and Tubes for Transportation of Dangerous Goods*.
- d. The cylinder used must include a collar to protect the cylinder valve, and the cylinder supply system must be arranged for vapor withdrawal.
- e. The pressure regulator and hose assembly (Fig. 9-1) supplied with this outdoor-cooking gas appliance must be used. Original and replacement pressure regulator and hose assemblies must be those specified by the manufacturer for connection with a cylinder connecting device identified as Type I by the *ANSI Z 21.58-2005/CGA 1.6-2005* (see PARTS LIST for ordering information).
- f. The propane-gas cylinder valve must be equipped with a cylinder connection coupling device, described as Type I in the standard defined in paragraph e. above. This device is commonly described as an Acme thread quick coupler.
- g. If the propane-gas cylinder comes with a dust plug, place the dust cap on the cylinder valve outlet whenever the cylinder is not in use.

## QUICK COUPLER OPERATION

**To connect the regulator/hose assembly to the propane-gas cylinder valve fitting:** Press the hand nut on the regulator over the Acme thread fitting on the cylinder valve. Turn the hand nut clockwise to engage the threads and tighten until snug.

The use of pliers or a wrench should not be necessary. Only cylinders marked "propane" may be used.

**To disconnect:** Turn the hand nut counterclockwise until detached (Fig. 9-1).

**Important:** Before using the unit, and after each time the cylinder is removed and reattached, check the hose for wear (see a.) and check all connections for leaks. Turn off the unit valves and open the main cylinder valve, then check connections with soapy water. Repair any leaks before lighting the unit.

**CAUTION:** Always turn the propane cylinder main valve off after each use, and before moving the unit and cylinder or disconnecting the coupling. This valve must remain closed and the cylinder disconnected while the appliance is not in use, even though the gas flow is stopped by a safety feature when the coupler is disconnected.

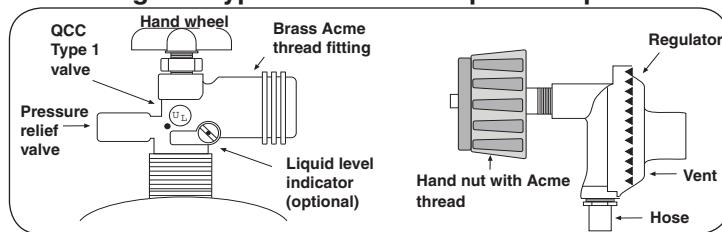
**Carefully** inspect the hose assembly each time before the gas is turned on. A cracked or frayed hose should be replaced immediately.

If the appliance is stored indoors, the cylinder must be disconnected and removed. Disconnected cylinders must be stored outdoors, out of the reach of children, with threaded valve plugs tightly installed, and must not be stored in a building, garage, or any other enclosed area.

## FOR YOUR SAFETY

- a. DO NOT store a spare propane-gas cylinder under or near this appliance.
- b. NEVER fill the cylinder beyond 80-percent full.
- c. IF THE INFORMATION IN a. AND b. IS NOT FOLLOWED EXACTLY, A FIRE CAUSING DEATH OR SERIOUS INJURY MAY OCCUR.

**Fig. 9-1 Type I Acme thread quick coupler**



# CONNECTING THE GAS TO THE OUTDOOR CAMPFYRE™

## IMPORTANT

Be sure you have read and understand all safety precautions and warnings contained in this manual.

**Note:** To install the Peterson Outdoor Campfyre™, you must have a gas-supply line that has been installed by a qualified professional technician in accordance with all local codes. **Refer to the PARTS LIST when installing the Outdoor Campfyre™.**

**CAUTION:** Installation and maintenance must be done by a qualified professional service person.

**Installer:** Read these instructions before installing this Outdoor Campfyre™. Be sure you understand all safety precautions and warnings contained in this manual.

### Tools Required:

1. Adjustable open-ended wrench
2. Pliers
3. Pipe compound resistant to all gasses or Teflon tape
4. Soapy water solution & brush for leak detection
5. Phillips-head screwdriver
6. Manometer (recommended for checking gas pressure)

## IMPORTANT

### CHECK GAS TYPE.

The gas supply you wish to use may not be the same as stated on the Outdoor Campfyre™ rating plate. If the gas supply is different, **CONVERT THE OUTDOOR CAMPFYRE™ FOR THE GAS SUPPLY YOU INTEND TO USE.**

**BE SURE THE GAS SUPPLY FOR THE OUTDOOR CAMPFYRE™ IS TURNED OFF.**

**BEFORE PROCEEDING, CAREFULLY READ ALL OF THE IMPORTANT SAFETY INFORMATION CONTAINED IN THIS OWNER'S MANUAL, INCLUDING:**

- A. PRE-INSTALLATION AND OUTDOOR CAMPFYRE™ PREPARATION SAFETY GUIDELINES
- B. INSTALLATION SAFETY GUIDELINES
- C. MINIMUM CLEARANCE TO COMBUSTIBLES (below)

**Note:** The burner air shutter **must be in place** when converting to and **using natural gas.** When converting to and **using propane gas,** the air shutter **must be removed.**

Burner air shutter in place for natural gas only (remove for propane gas)

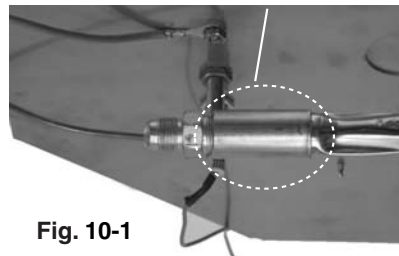


Fig. 10-1

## MINIMUM CLEARANCE TO COMBUSTIBLES

### Clearances to Combustible Construction:

- Sidewalls: 36" from side of surround opening (Fig. 10-2)  
Ceiling: **Nothing should be above the Outdoor Campfyre™**  
Flooring: 0" - Can be installed on deck, slab, floor, etc.

The dimensions shown in Fig. 10-2 are **MINIMUM CLEARANCES** to maintain when you install this Outdoor Campfyre™. **ALL SIDES** of the enclosure opening **MUST BE AT LEAST 36"** from any combustible side walls. The unit **MUST NOT BE** installed under any type of ceiling or overhang.

**Note:** Nothing should be above the Outdoor Campfyre™.

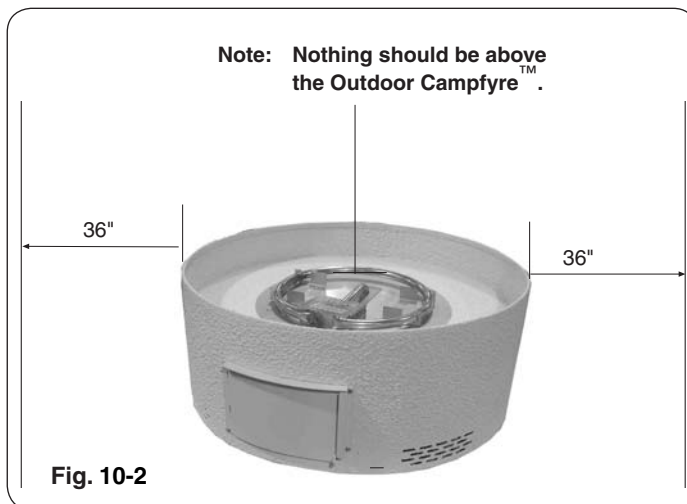


Fig. 10-2

## CONNECTING THE GAS TO THE BURNER SYSTEM (Cont.)

Place the Outdoor Campfyre™ enclosure at the installation location, locating it over the gas-supply pipe. Supply pipe should not protrude more than 3" up into the fire pit. Ensure flex connector does not become kinked, damaged, or allow unit to rest on it.

**Important:** This unit must be installed at least 36" from any combustible walls or material. **IT MUST NOT BE INSTALLED UNDER ANY TYPE OF CEILING OR OVERHANG.**

1. Remove the four (4) retaining screws from the burner pan assembly (Fig. 11-1).
2. Carefully lift pan assembly (Fig. 11-2, shows remote unit). This will allow access to center of fire pit and flex connector kit. Attach flex connector kit to main gas-supply line using Teflon tape or pipe compound resistant to propane gas (Fig. 11-3, shows manual unit). Tighten connections.
3. Turn on the gas supply, ignite the burner, and test at all connections for leaks using a soapy water solution. If bubbles appear, a leak is present. Turn off the gas and tighten at all connections. Repeat until no leaks are present. **Never use a flame to check for leaks.**
4. When testing is complete and no leaks are found, re-center the burner assembly in the enclosure. Make certain that no part of the assembly protrudes beyond the face of the enclosure, no wires come disconnected or loose, and the burner pan sits level. Replace and tighten the four (4) retaining screws.

Fig. 11-1

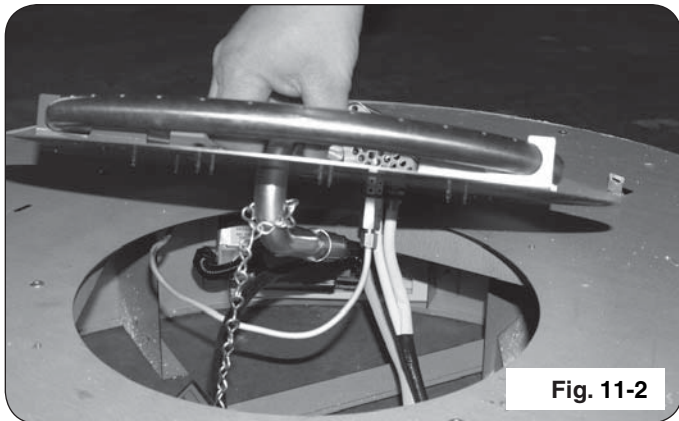
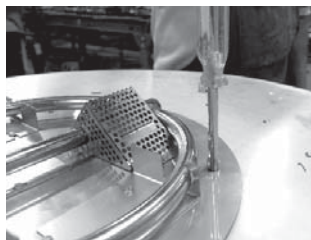
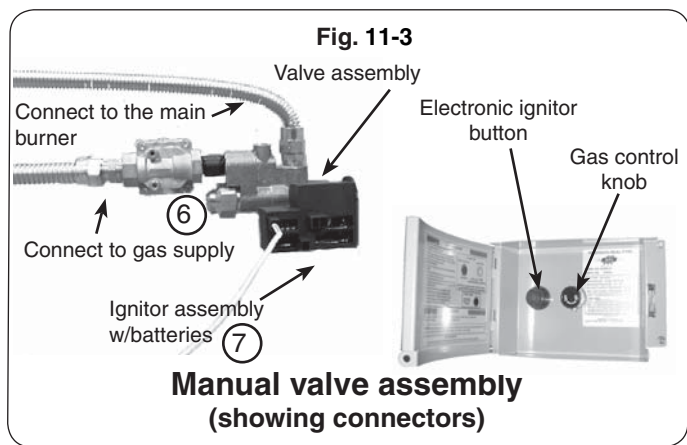


Fig. 11-2



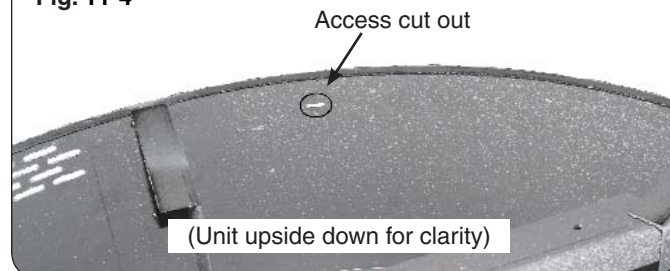
Manual valve assembly (showing connectors)

### ALTERNATE GAS INSTALLS THROUGH SIDEWALL

It is ideal that any electrical and/or gas lines be brought up from beneath the location the fire pit is to be installed. However, should your setup require that lines be ran from another location into the fire pit, knock outs are available on the side wall of the fire pit. See Fig. 11-4.

**Note:** Carefully punch out the circles to prevent any stucco from chipping off of the underlying metal wall.

Fig. 11-4



(Unit upside down for clarity)

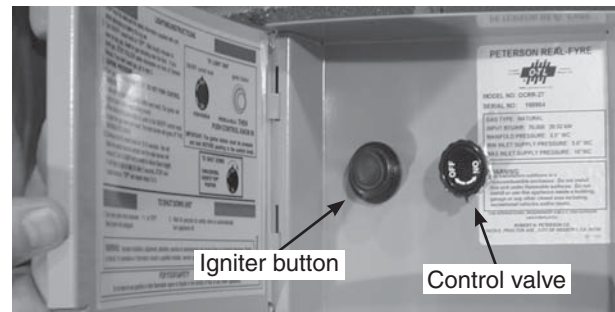


Fig. 11-5

Control valve

For the remote model, the next stage is installation of the batteries (see the following page).

**For the manual valve model, the battery in the igniter module is factory installed.**

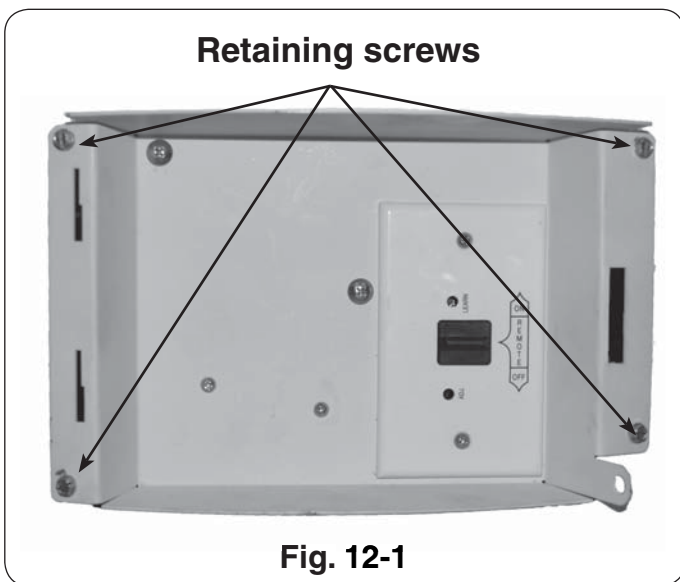
## CONNECTING THE GAS TO THE BURNER SYSTEM (Cont.)

**CAUTION:** MAKE SURE THE UNIT IS CONNECTED TO THE GAS AND HAS BEEN TESTED FOR LEAKS BEFORE YOU INSERT THE BATTERIES.

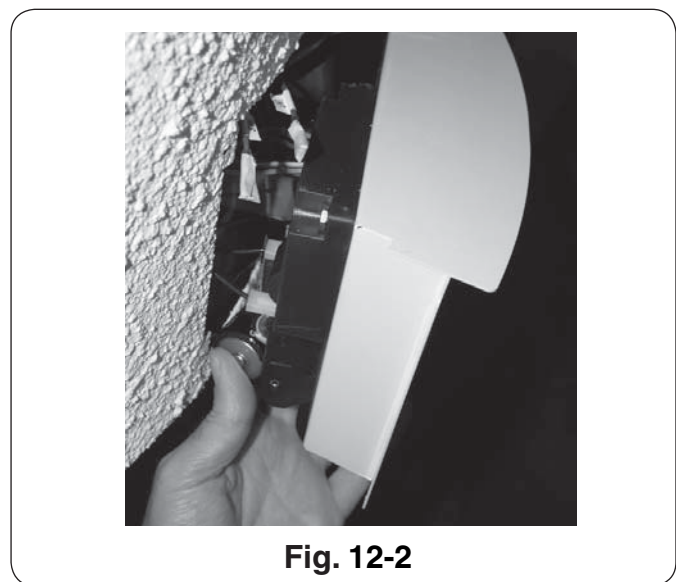
### INSTALLING THE BATTERIES FOR THE REMOTE UNIT

You may access the rear of the control panel by removing the door and then the four (4) panel securing screws (Fig. 12-1) to insert or replace the "D" batteries. Insert two (2) "D" batteries as shown in Fig. 12-2, taking care not to disconnect or loosen wiring. Replace the control panel and screw it into the enclosure. Replace the door.

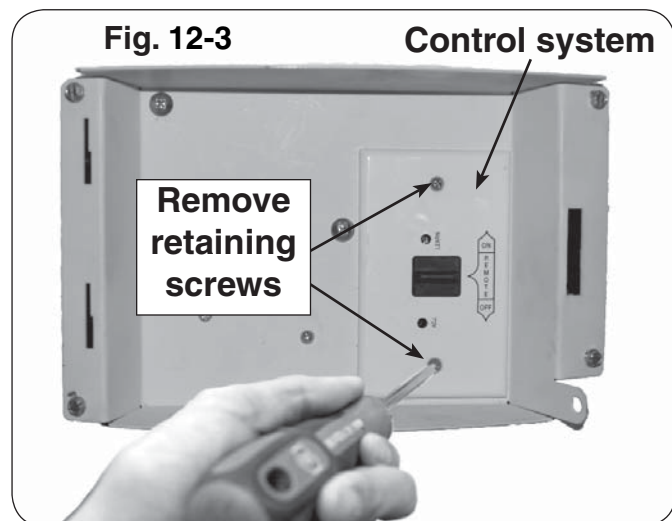
To access the "AA" battery pack, unscrew and remove the two (2) retaining screws on the control system (Fig. 12-3). Remove the control system and then slide open the battery pack lid as shown in Fig. 12-4. Replace the old batteries with four (4) new "AA" batteries. Resecure the battery pack lid and return the control system into the control panel. Screw in the two (2) retaining screws.



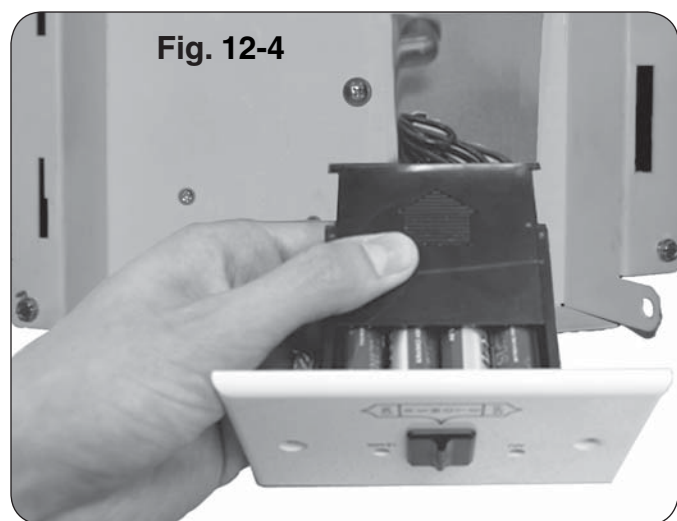
Front of remote unit control panel with door removed



Replacing the batteries behind the remote Campfyre™ unit control panel



Unscrew control system

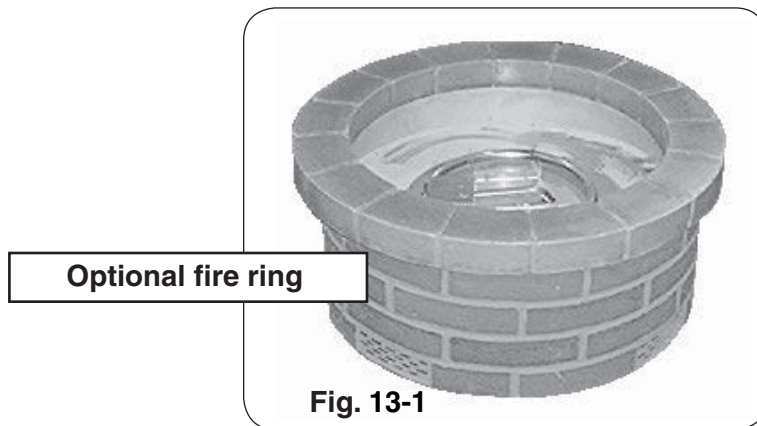


Battery pack exposed

## INSTALLATION OF THE OUTDOOR CAMPFYRE™ RING

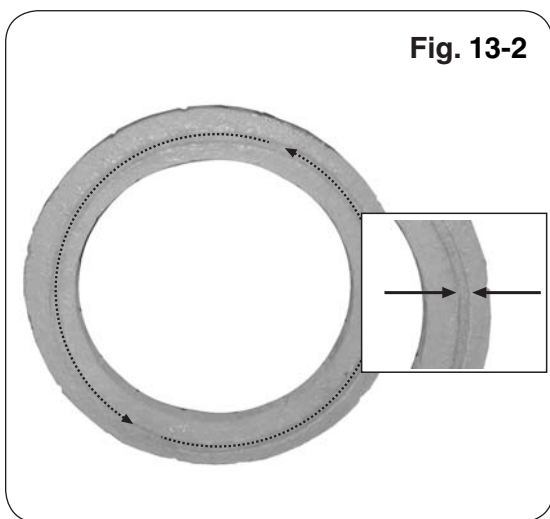
The **optional Campfyre™ ring** (Fig. 13-1) adds a decorative feature to the Outdoor Campfyre™ and is simple to install. First, remove the ring from its packaging and make sure that it has not been damaged during shipping. Then follow the simple instructions below.

**CAUTION:** Fire ring is heavy.



### CAMPFYRE™ RING PLACEMENT

When placing the fire ring onto the Outdoor Campfyre™ (Fig. 13-3), carefully lift the fire ring over the Campfyre™ and place it on top of the base, making sure that the inner groove (as seen in Fig. 13-2) is placed directly over the rim (Fig. 13-3). Ensure it is firmly in place before proceeding to Lava Chunk and log placement.



## CONVERTING TO A DIFFERENT GAS TYPE

To convert **manual units** from propane to natural gas or from natural to propane gas, carefully follow the steps below:

1. **SHUT OFF THE GAS SUPPLY TO THE UNIT AND ANY NEARBY ELECTRICAL SOURCES OR APPLIANCES.**
2. If present, remove all decorative media from the unit.
3. Remove the screws attaching the burner pan to your enclosure.
4. Detach the thermocouple (taking care not to kink it) from the safety valve (see Fig. 14-2 for location).
5. Carefully detach the flex connector attached to the orifice holder (see Fig. 14-4) and unscrew the orifice holder from the burner pipe (see Fig. 14-5).
6. Remove the orifice from the holder (see Fig. 14-5) and replace with the proper-sized one for your gas requirement. Propane gas requires a #40 (drill size) orifice. Natural gas requires a #23 orifice.

**Note:** If you are converting **to and using natural** gas you **MUST** install the air shutter over burner pipe to cover the air holes (see Fig. 14-5). For **propane** (L.P.) gas, remove the air shutter.

Replace the orifice holder and reattach the connector from the valve (see Fig. 14-4). The regulator must now be converted to the new gas type.

7. The regulator is situated after the valve (see Fig. 14-2), behind the control panel. To convert the regulator to the required gas type:
  - a) Unscrew and remove the cap (see Fig. 14-1) from the regulator, extracting the converter.

**Note:** As installed, the regulator cap may be located underneath the regulator. If necessary, carefully rotate the regulator to access the cap.

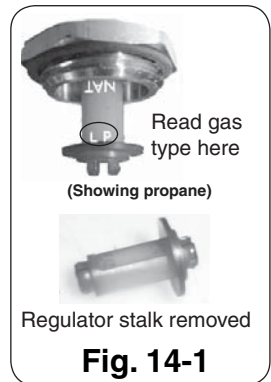
- b) Remove the converter (the red plastic stalk, Fig. 14-1) by carefully pulling it away from the center of the cap (it will snap out of its seating).
  - c) Turn the converter around and replace carefully into the center of the cap (it will snap into place). **Check that you can read the type of gas the unit is set for.**

**Note:** **EACH END OF THE PLASTIC CONVERTER IS EMBOSSED WITH EITHER THE LETTERS "NAT" OR "L.P." FOR THE RESPECTIVE GAS TYPE ("NAT." for natural - "L.P." for propane). WHEN THE CONVERTER IS IN THE CAP AND THE CAP IS HELD UPPERMOST, THE LETTERS SEEN (AT THE BOTTOM OF THE STALK) INDICATE THE GAS THAT THE REGULATOR IS SET UP FOR.** (Fig. 14-1 shows the converter set for propane gas.)

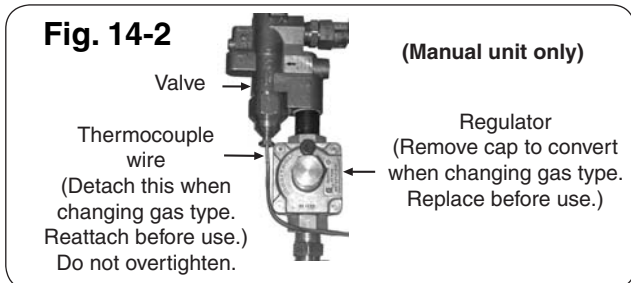
- d) Replace the cap and converter into the regulator and screw down until snug.

8. Once the above steps are complete, reattach the thermocouple and ignitor wires.

9. Restore your gas supply and check for leaks per the INSTALLATION section. When no leaks are detected, fasten the burner pan back into place on the enclosure and replace the decorative media.

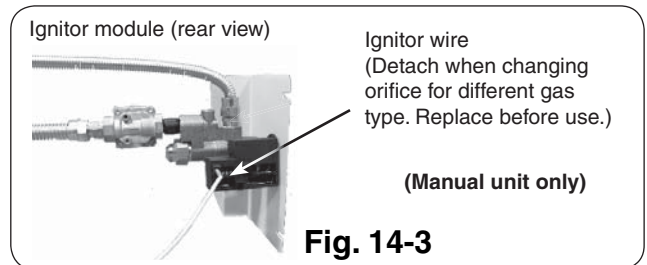


**Fig. 14-1**

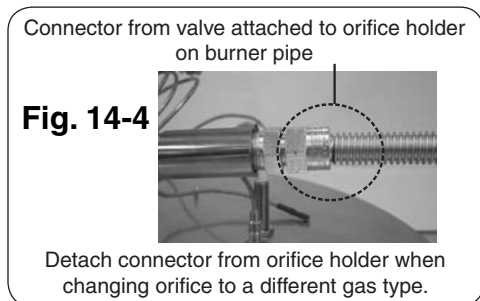


**Fig. 14-2**

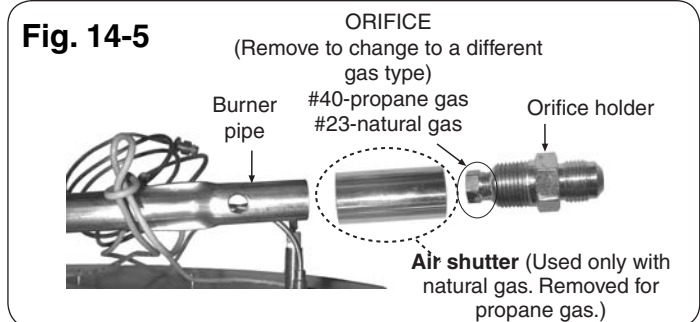
(Manual unit only)



**Fig. 14-3**



**Fig. 14-4**



**Fig. 14-5**

## DECORATIVE MEDIA OPTIONS

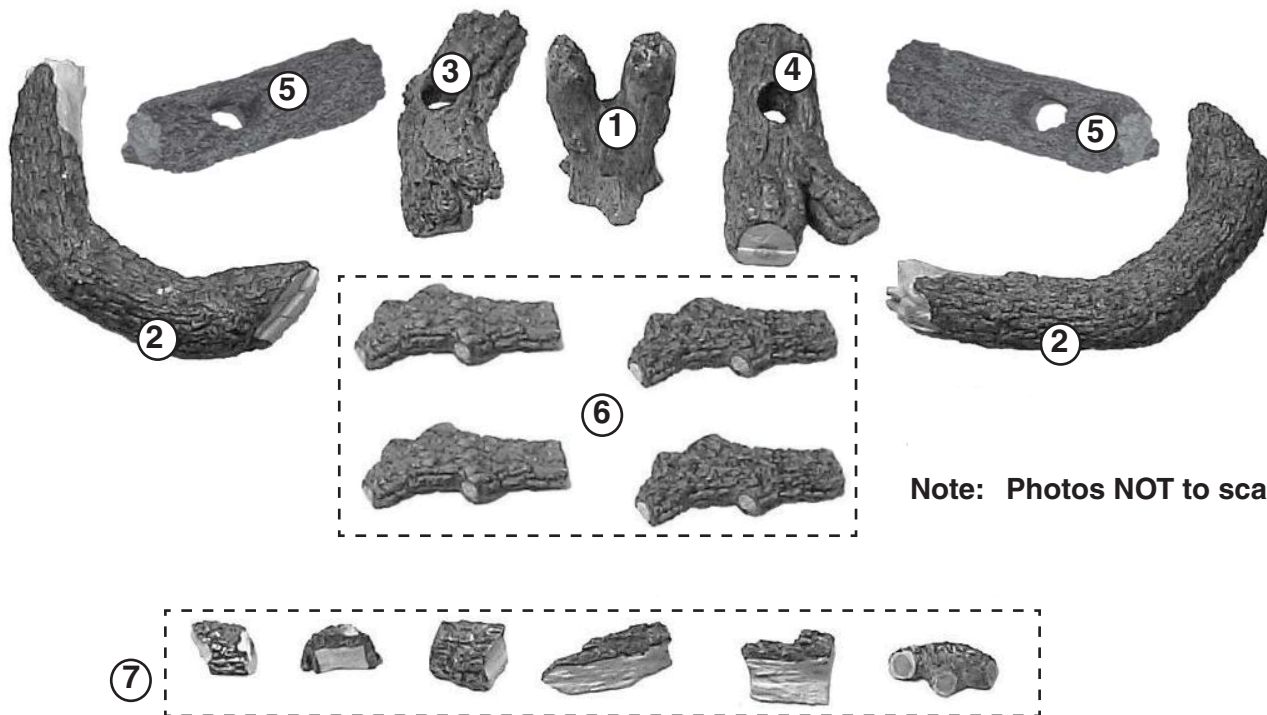
The unit has several options for decorative media, each with a different set of components and setup instructions. Find the section that pertains to your model and follow those setup instructions.

**Note:** Lava media (**included with burner**) is always placed on the burner first in each option. This provides an important base for the diffusion of gas and air.

## OPTIONAL CAMPFYRE LOGS

### OCL-34

| <u>Item</u> | <u>Part #</u> | <u>Description</u>        | <u>Qty</u> |
|-------------|---------------|---------------------------|------------|
| 1.          | OCL-8YC       | "Y" center support log    | 1          |
| 2.          | OCL-15BC      | Curved bottom log         | 2          |
| 3.          | OCL-12T       | 12" top log with knothole | 1          |
| 4.          | OCL-13T       | 13" top log with knothole | 1          |
| 5.          | HRDL-12T      | 12" top log               | 2          |
| 6.          | RDL-7T        | 8" top log                | 4          |
| 7.          | WC-6          | Wood chips (6 pcs.)       | 1          |



## OPTIONAL CAMPFYRE LOGS (cont.)

### WARNING

This screen must be clear and free of obstructions at all times to ensure proper operation (Fig. 16-1).

### Screen with lava on burner pan

DO NOT PLACE  
LAVA MEDIA  
ON THE SCREEN

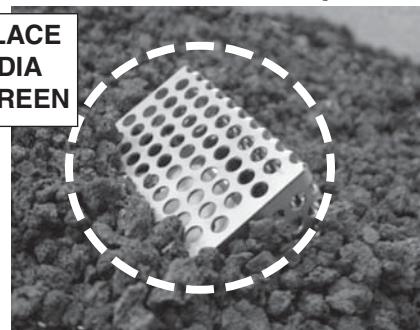


Fig. 16-1

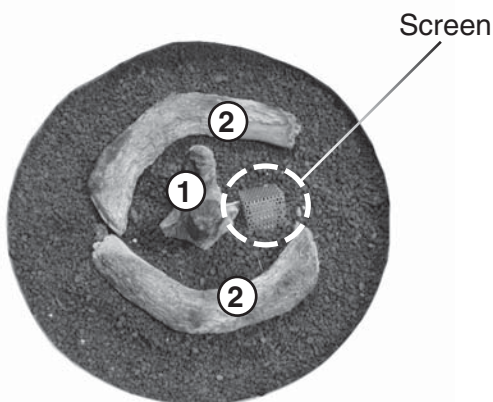
### LAVA MEDIA PLACEMENT

1. **FIRST**, pour the 10 lb bag of lava granules into the burner pan, evenly covering the burner pan assembly with the exception of the screen. **THEN**, pour the 6 lb bag of lava coals into the burner pan, evenly covering the burner pan assembly with the exception of the screen. (Granules are smaller in size, coals are larger.)

### LOG PLACEMENT

1. Place the Y-shaped support log (Log #1) on the lava in the center of the enclosure (Fig.16-2).

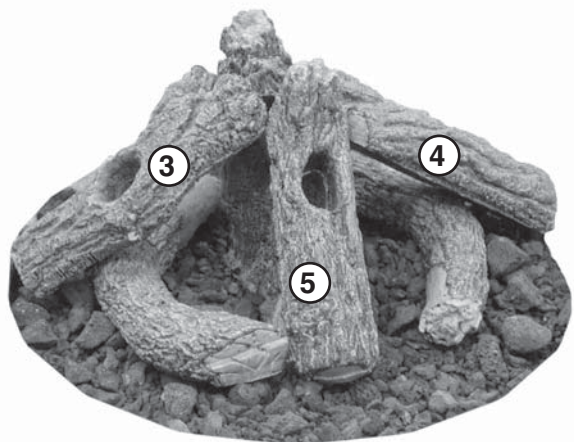
Fig. 16-2 Steps 1 & 2



**CAUTION:** CAMPFYRE OR DECORATIVE MEDIA WILL REMAIN HOT FOR SOME TIME AFTER USE. IF YOU NEED TO REPOSITION ANY DECORATIVE MEDIA, USE HEAT-RESISTANT GLOVES OR ALLOW TO COOL BEFORE HANDLING.

2. Place the two curved bottom logs (Logs #2) on opposite sides of the support log so as to keep the screen clear (Log #1). (See Fig.16-2.)
3. Rest the two (2) knothole top logs (Log #3, Log #4) against the center support log with one end in the lava.
4. Rest the next two top logs (Logs #5) against the support log with the other ends resting in the lava, forming a teepee-type stack (Fig. 16-3).

Fig. 16-3 Steps 3 & 4



The finished  
log stack

Fig. 16-4 Steps 5 & 6



5. Place the four (4) smallest logs (PARTS LIST, item #6) so they rest on the curved bottom logs as desired (Fig. 16-4).
6. Place the six (6) wood chips (PARTS LIST, item #7) as desired around the log stack (Fig. 16-4).

## OPTIONAL BEACHWOOD LOGS AND/OR VOLCANIC STONE

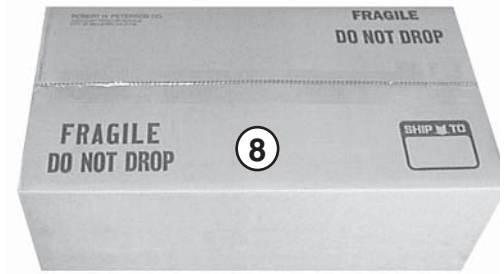
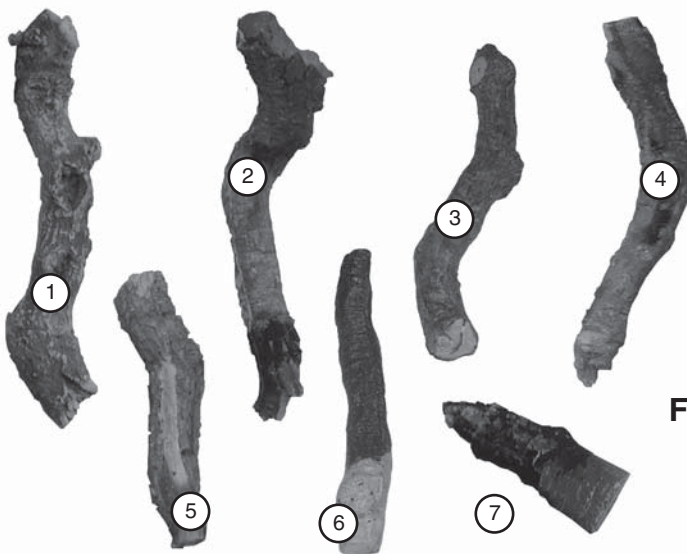


Fig. 17-1

### OCBW-34

| #  | Description           | Part Number | Qty |
|----|-----------------------|-------------|-----|
| 1. | Knotted log           | OCBWL-17    | 1   |
| 2. | Hooked log            | OCBWL-18    | 1   |
| 3. | Crooked log           | OCBWL-16    | 1   |
| 4. | Curved log            | OCBWL-15    | 1   |
| 5. | Stripped log          | OCBWL-12    | 1   |
| 6. | Long charred log      | OCBWL-20    | 1   |
| 7. | Short charred log     | OCBWL-9     | 1   |
| 8. | Volcanic stones (box) | VS-25       | 1   |

Although log placement may vary, suggested log placement for the Beachwood log set is provided below. These log placements will allow for superior flame pattern and appearance. Please read these instructions completely and carefully before beginning.

### LAVA AND STONE PLACEMENT

**WARNING:** Use only parts specifically approved for use with this Real-Fyre® gas log set. Failure to do so may result in property damage or personal injury. Check with your local Real-Fyre® dealer if you need more information.

#### Screen with lava on burner pan

**DO NOT PLACE  
LAVA MEDIA  
ON THE SCREEN**

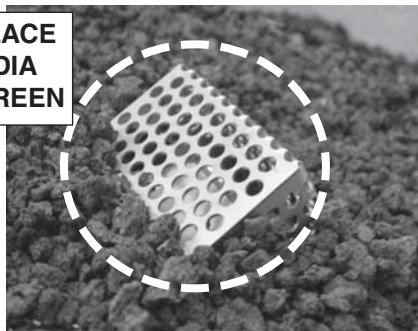


Fig. 17-2

1. **FIRST**, pour the 10 lb bag of lava granules into the burner pan, evenly covering the burner pan assembly with the exception of the screen. **THEN**, pour the 6 lb bag of lava coals into the burner pan, evenly covering the burner pan assembly with the exception of the screen. (Granules are smaller in size, coals are larger.)

2. Pour the volcanic stones on top to fill the whole burner pan.

With the ignitor screen clear of lava media and volcanic stones distributed on top of the lava, nearly any log placement is possible. **It is also possible to use only the Volcanic Stones and no logs at all.**

Some general guidelines include always placing the flat side of each log downward or inward and making sure the logs are positioned so they are stable and will not shift or roll. Logs must remain in the burner pan when hot.

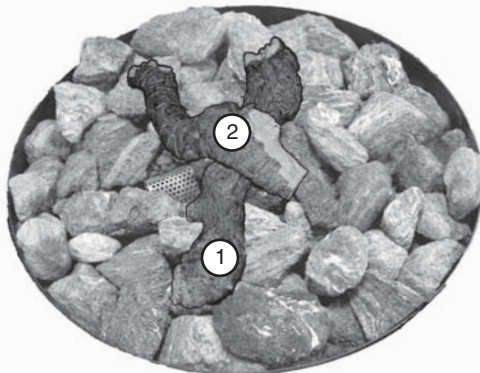


Fig. 17-3

## OPTIONAL BEACHWOOD LOGS (cont.)

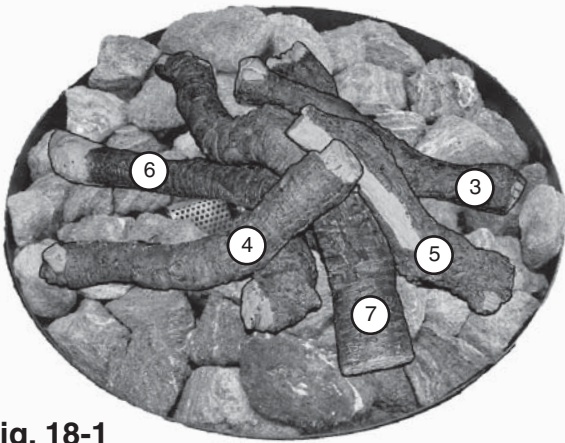


Fig. 18-1

### Beachwood Log Set Other options

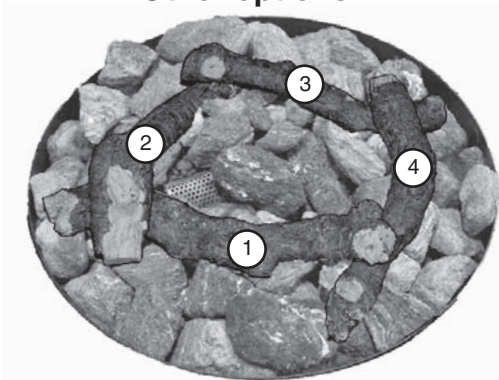


Fig. 18-2

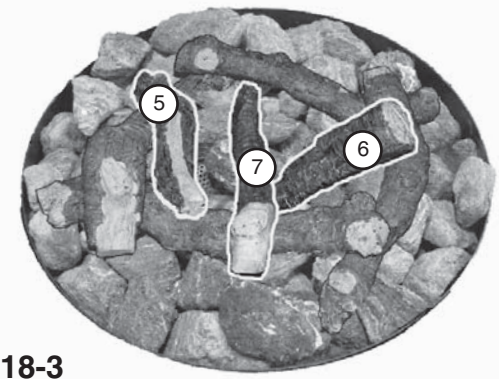


Fig. 18-3

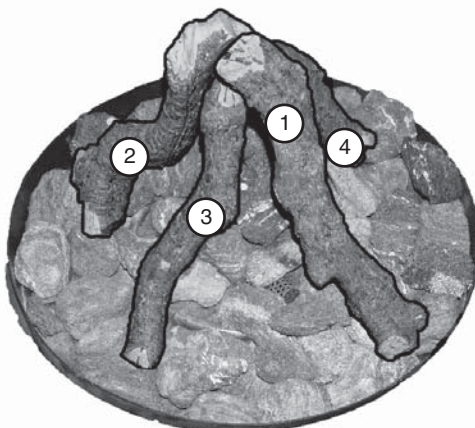


Fig. 18-4

**CAUTION:** CAMPFIRE OR DECORATIVE MEDIA WILL REMAIN HOT FOR SOME TIME AFTER USE. IF YOU NEED TO REPOSITION ANY DECORATIVE MEDIA, USE HEAT-RESISTANT GLOVES OR ALLOW TO COOL BEFORE HANDLING.

### LOG PLACEMENT OPTION TWO - LOG SQUARE

1. Lay Log #1 across the volcanic stone, then lay the hooked part of Log #2 over one end of Log #1 at an angle of approximately 90 degrees (see Fig. 15-2).
2. Lay an end of Log #3 over the unattached end of Log #2 at a 90-degree angle (see Fig. 18-2).
3. Place one end of Log #4 over the open end of Log #3 and the other end underneath the open end of Log #1, creating a kind of square (see Fig. 18-2).
4. Lay the remaining logs across the already positioned logs in an attractive pattern (see Fig. 18-3).

### LOG PLACEMENT OPTION THREE - LOG "TEEPEE"

1. Place the ends of three or four logs into the volcanic stones with their flat sides facing inward and their tops pointed upward. Then lean their other ends against each other at an angle in the center of the fire ring (see Fig. 18-4).
2. Once you have a stable set of logs to use as a "teepee" frame, place the other logs similarly as desired (see Fig. 18-5).

Enjoy your log set. After the logs are placed, consider how changing their arrangement could produce even more pleasing flame patterns. Always observe the caution at the top of this page and the guidelines on the previous page.

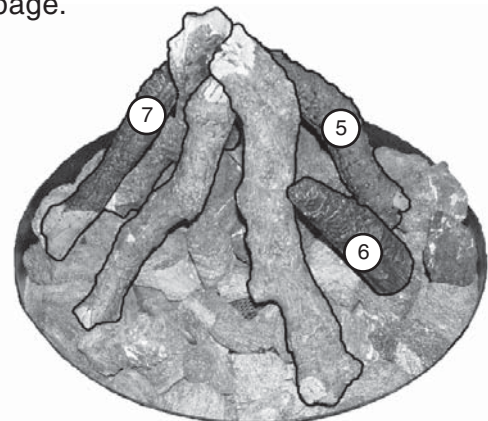
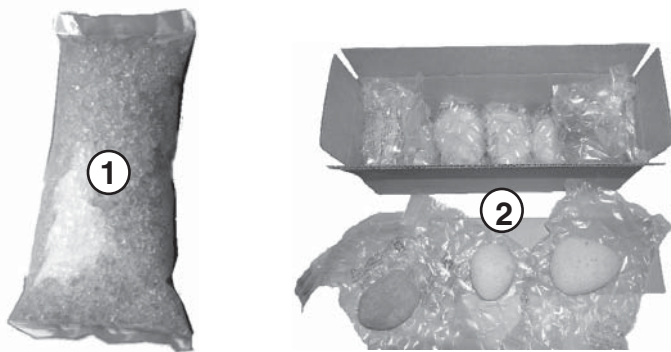


Fig. 18-5

## OPTIONAL GLASS/GEMS OR RIVER ROCK ON GLASS/GEMS

| Item | Description                  | Part Number | Qty |
|------|------------------------------|-------------|-----|
| 1.   | Glass (10 lb bag)            | GL-10-x*    | 2   |
| or   | Gems (10 lb bag)             | GLG-10-x*   |     |
| 2.   | Box of river rock (optional) | STN-10      | 1   |

\* Replace "x" in model number with the applicable glass/gem code for your chosen media. Glass and gems are available in various colors; contact your dealer for further details.



**Note:** Installation is the same for glass and gems. Glass shown here.

### WARNING

This screen must be clear and free of obstructions at all times to ensure proper operation (Fig. 19-1).

**Screen with lava granules on burner pan**

**DO NOT PLACE  
LAVA GRANULES  
ON THE SCREEN**

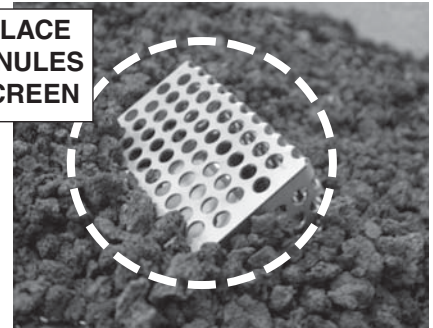


Fig. 19-1

### LAVA GRANULE PLACEMENT

**Important:** DO NOT use the 6 lb bag of lava coals when installing this burner system with glass. Set the lava coals aside or discard. Only use the 10 lb bag of lava granules. (The granules are smaller in size.)

1. Pour the 10 lb bag of lava granules into the burner pan, evenly covering the burner pan assembly with the exception of the screen.

### GLASS/GEM PLACEMENT

1. Pour the glass/gems out of the bag(s), evenly covering the lava but not the screen (Fig. 19-2).

**Note:** If extra glass remains after properly filling the pan, it may be stored for future use.

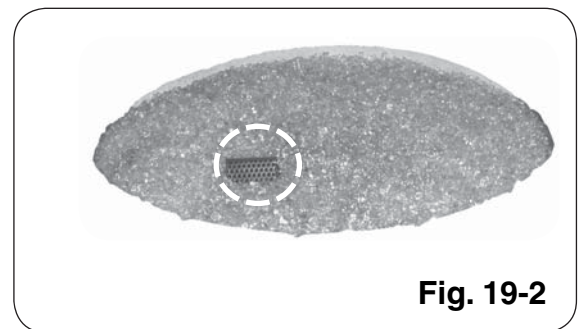


Fig. 19-2

### STONE PLACEMENT

1. Place river stones in a decorative pattern on top of the glass/gems. Do not cover the screen.

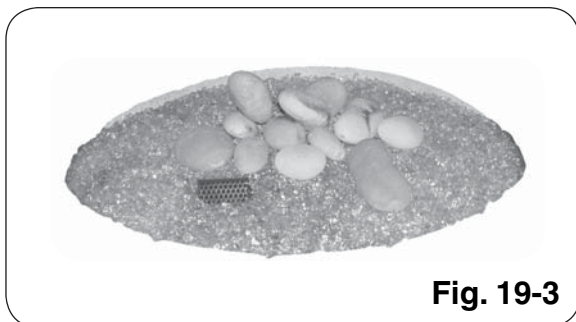


Fig. 19-3

**CAUTION:** CAMPFYRE OR DECORATIVE MEDIA WILL REMAIN HOT FOR SOME TIME AFTER USE. IF YOU NEED TO REPOSITION ANY DECORATIVE MEDIA, USE HEAT-RESISTANT GLOVES OR ALLOW TO COOL BEFORE HANDLING.

## LOG SET NOTES PAGE

Please use this page to record any information about your log set that you may want to have at hand.

# OPERATING THE UNIT - LIGHTING AND EXTINGUISHING

## FOR YOUR SAFETY, READ BEFORE LIGHTING

**WARNING: IF YOU DO NOT FOLLOW THESE INSTRUCTIONS EXACTLY, A FIRE OR EXPLOSION MAY RESULT, CAUSING PROPERTY DAMAGE, PERSONAL INJURY, OR LOSS OF LIFE.**

- A. BEFORE LIGHTING**, smell all around the unit area for gas. Be sure to smell next to the floor, because some gas is heavier than air and will settle on the floor.
- B. WHAT TO DO IF YOU SMELL GAS**
  1. **Shut off the gas to the appliance.**
  2. **Extinguish any open flame.**
  3. **If odor continues, immediately call your gas supplier or the fire department.**
- C.** Use only your hand to push in or move controls. Never use tools. If the knob will not push in or turn by hand, **DO NOT** try to repair it. Call a qualified professional service technician. Force or attempted repair may result in fire or explosion.
- D. DO NOT** use the unit if any part has been underwater. Immediately call a qualified service technician to inspect the unit and to replace any part of the control system and any gas control that has been underwater.

## 01 VALVE SERIES LIGHTING INSTRUCTIONS

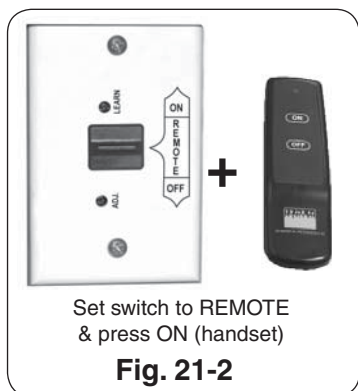
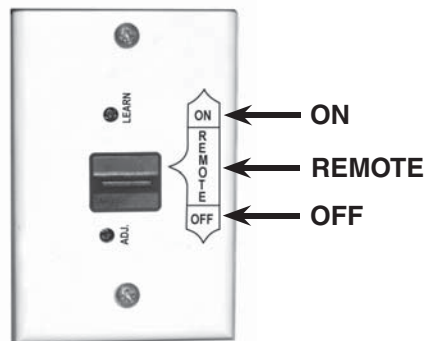
**Note: For any lighting method, no gas will flow to the main burner unless the pilot is lit and stable.**

1. **STOP!** Read the safety information above.
2. Turn the gas valve to the **ON** position.
3. **Lighting the unit using remote handset**
  - a. Slide the ON/REMOTE/OFF switch (O/R/O) to **REMOTE** setting (see Fig. 21-1).
  - b. Point the top of the remote handset toward the control panel and press the **ON** button on the handset. The ignitor will spark and a rapid clicking noise will be heard. The pilot will light. When the pilot flame becomes stable (about 10 seconds), gas will flow to the main burner, and the main burner will ignite.
4. **Lighting the unit without using the remote**
  - a. Slide the O/R/O switch to the **ON** setting (top); the ignitor will spark, and a rapid clicking noise will be heard. The pilot will light. When the pilot flame becomes stable (about 10 seconds), gas will flow to the main burner, and the main burner will ignite.

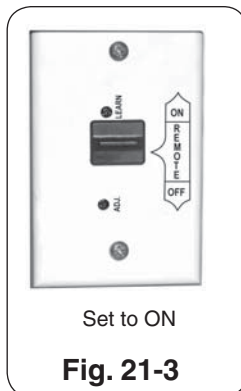
### SHUTTING OFF THE UNIT

5. **Shutting off the unit using remote handset**
  - a. Slide the ON/REMOTE/OFF switch (O/R/O) to **REMOTE** position (center).
  - b. Point the top of the remote handset toward the control panel and press the **OFF** button (handset). Main burner and pilot will extinguish.
6. **Shutting off the unit without using remote**
  - a. Slide the O/R/O switch to the **OFF** setting. Main burner and pilot will extinguish.

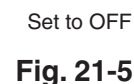
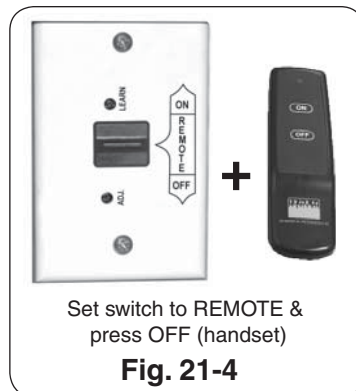
**Fig. 21-1 Control panel**



OR



OR



# FONCTIONNEMENT DE L'ÎLE UNITÉ - ÉCLAIRAGE ET S'ÉTEINDRE

Pour votre sécurité lisez avant d'allumer

**Avertissement. Quiconque ne respecte pas à la lettre les instructions dans la présente notice risque de déclencher un incendie ou une explosion entraînant des dommages, des blessures ou la mort.**

AVANT DE S'ALLUMER, sentez tous autour de l'île unité secteur pour le gaz. Soyez sûr de sentir à côté de la terre, parce qu'un certain gaz est plus lourd que l'air et arranger sur le plancher. SI VOUS SENTEZ LE GAZ, SUIVEZ LES INSTRUCTIONS SUR La Page 1

N'emploient pas l'île unité si n'importe quelle partie a été sous-marine. Appelez immédiatement un technicien qualifié de service professionnel pour inspecter l'île unité et pour remplacer n'importe quelle partie du système de commande et de n'importe quel gaz commandez qui a été sous-marine.

N'utilisez pas cet appareil s'il a été plongé dans l'eau, même partiellement. Faites inspecter l'appareil par un technicien qualifié et remplacez toute partie du système de contrôle et toute commande qui ont été plongés dans l'eau.

## 01 INSTRUCTIONS D'ÉCLAIRAGE DE SÉRIE DE VALVE

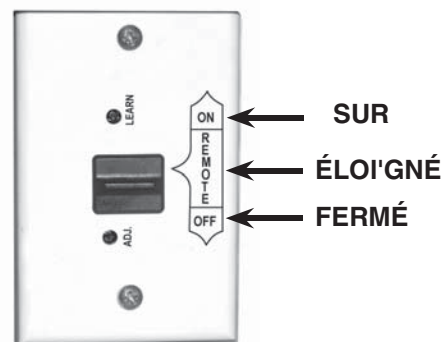
**Note: Pour tout combinatin de l'éclairage utilisé, le gaz ne coulera pas au brûleur principal à moins que le pilote soit allumé et est logé dans une écurie.**

- 1. ARRÊTEZ!** Lisez l'information de la sécurité fournie l'unité.
- 2. Tournez la valve du gaz au "SUR" place**
- 3. Allumer le unité qui utilise le combiné éloigné**
  - a) Poussée le. Éloigné/Sur/Fermé. changement (R/O/O) au. Éloigné. mettre (centre)( illus. 22-1).
  - b) Point le sommet du combiné éloigné vers le tableau de bord et presse le "SUR" bouton sur le combiné. Les ignitor jetteront des étincelles, un bruit du cliquetis rapide sera entendu. Le pilote allumera. Quand la flamme pilote devient stable, (approximativement 10 secondes) le gaz coulera au brûleur principal et le brûleur principal allumera
- 4. Allumer sans utiliser éloigné.**
  - b) Poussée le. R/O/O. changement au. SUR. mettre (sommet). Les ignitor jetteront des étincelles, un bruit du cliquetis rapide sera entendu. Le pilote allumera. Quand la flamme pilote devient stable, (approximativement 10 secondes) le gaz coulera au brûleur principal et allumer.

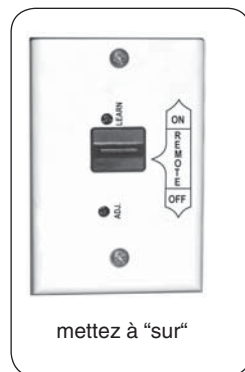
### Couper le unité

- 5. Couper le unité qui utilise le combiné éloigné**
  - a) Quand utiliser le Combiné Éloigné; Assurez le changement est dans la place "Éloignée" (centre) Presse le "Fermé" bouton sur le combiné. Le brûleur principal et pilote seront éteints.
- 6. Couper le unité sans utiliser le combiné éloigné**
  - a) Quand n'utiliser pas Combiné Éloigné; Poussez les ON/OFF éteignent à. Le brûleur principal et le pilote sera éteint

illus. 22-1 panneau de commande



OU



OU



## OPERATING THE UNIT - LIGHTING AND EXTINGUISHING

### FOR YOUR SAFETY, READ BEFORE LIGHTING

**WARNING: IF YOU DO NOT FOLLOW THESE INSTRUCTIONS EXACTLY, A FIRE OR EXPLOSION MAY RESULT, CAUSING PROPERTY DAMAGE, PERSONAL INJURY, OR LOSS OF LIFE.**

- A. BEFORE LIGHTING**, smell all around the unit area for gas. Be sure to smell next to the floor, because some gas is heavier than air and will settle on the floor.
- B. WHAT TO DO IF YOU SMELL GAS**
1. **Shut off the gas to the appliance.**
  2. **Extinguish any open flame.**
  3. **If odor continues, immediately call** your gas supplier or the fire department.
- C.** Use only your hand to push in or turn the gas control knob. Never use tools. If the knob will not push in or turn by hand, **DO NOT** try to repair it. Call a qualified professional service technician. Force or attempted repair may result in fire or explosion.
- D. DO NOT** use the unit if any part has been underwater. Immediately call a qualified service technician to inspect the unit and to replace any part of the control system and any gas control that has been underwater.

## MANUAL (PIEZO) LIGHTING INSTRUCTIONS

1. **STOP!** Read the safety information above.
2. Press and hold the electric ignitor button. The ignitor will begin to spark with a rapid clicking sound.
3. While holding the ignitor button in, push in the ON/OFF control knob to open the gas valve.
4. Continue to hold the knob in for 10-15 seconds this will allow the safety valve to engage, and the main burner will ignite and remain lit. After releasing the knob turn the ON/OFF control knob to adjust flame height. If unit fails to light at step 4 after five (5) seconds, **STOP**, turn control knob to **OFF**, wait 5 minutes, and repeat steps 2 & 3.

**Note:** If the burner will not stay lit after several tries, turn the gas control knob to **OFF** and call your service technician or the gas supplier.

To turn the unit off, turn the ON/OFF valve fully to **OFF**.

**Fig. 23-1**



# FONCTIONNEMENT DE L'ÎLE UNITÉ - ÉCLAIRAGE ET S'ÉTEINDRE

POUR VOTRE SÛRETÉ, LISEZ AVANT DE S'ALLUMER

## AVERTISSEMENT

**SIVOUS NE SUIVEZ PAS CES INSTRUCTIONS EXACTEMENT, UNE INCENDIE OU UNE EXPLOSION PEUT RÉSULTER, ENTRAÎNANT DES DÉGATS MATÉRIELS, DES BLESSURES, OU LA PERTE DE LA VIE.**

- A. AVANT DE S'ALLUMER**, sentez tous autour du secteur extérieur de feu de camp pour le gaz. Soyez sûr de sentir à côté du plancher, parce qu'un certain gaz est plus lourd que l'air et arrangera sur le plancher.
- B. CE QUI À FAIRE SI VOUS SENTEZ LE GAZ**
- 1. Coupez le gaz à l'appareil.**
  - 2. Éteignez-vous n'importe quelle flamme nue.**
  - 3. Si l'odeur continue, appelez immédiatement votre fournisseur de gaz ou le département de feu.**
- C.** Utilisez seulement votre main pour enfoncer ou pour tourner le bouton de commande de gaz. N'utilisez jamais les outils. Si le bouton n'enfoncera pas ou ne tournera pas à la main, n'essayez pas de le réparer. Appelez un technicien qualifié de service professionnel. La force ou la réparation essayée peut avoir comme conséquence l'incendie ou l'explosion.
- D.** N'employez pas le feu de camp extérieur si n'importe quelle partie a été sous-marine. Appelez immédiatement un technicien qualifié de service pour inspecter le feu de camp extérieur et pour remplacer n'importe quelle partie du système de commande et de n'importe quelle commande de gaz qui a été sous-marine.

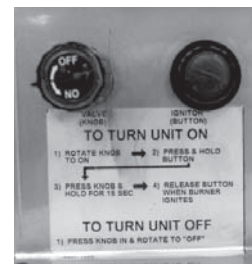
## INSTRUCTIONS (PIÉZO-ÉLECTRIQUES) MANUELLES D'ÉCLAIRAGE

- 1. ARRÊT!** Lisez l'information de sûreté ci-dessus.
- Appuyez sur et tenez le bouton électrique d'ignitor. L'ignitor commencera à étinceler avec un bruit cliquant rapide.
- Tout en tenant le bouton d'ignitor dedans, enfoncez le bouton de commande "marche/arrêt" pour ouvrir le clapet à gaz.
- Continuez à tenir le bouton dedans pendant 10-15 secondes où ceci permettra à la soupape de sûreté de s'engager, et le brûleur principal mettra à feu et rester s'est allumé. Après avoir libéré le bouton, tournez le bouton de commande "marche/arrêt" pour ajuster la taille de flamme. Si l'unité ne s'allume pas à l'étape 4 après cinq (5) seconde, S'ARRÊTENT, tournent le bouton de commande à AU LOIN, attendent 5 minutes, et répètent les étapes 2 et 3.

**Note:** Si le brûleur ne restera pas s'allumait après que plusieurs essais, tournent le bouton de commande de gaz à AU LOIN et appellent votre technicien de service ou le fournisseur de gaz.

Pour arrêter l'unité, tournez la valve "marche/arrêt" entièrement à AU LOIN.

illus. 24-1



## OPERATION

Each installation site for any unit presents its own unique combustion environment. Specific factors such as weather, wind currents, yard debris, altitude, drafts, the size of the surrounding area, all have an influence on the proper operation of the unit. A normally operating unit will demonstrate the following characteristics:

- a) A lively, realistic yellow flame,
- b) Odor-free.
  - If the flame is not clean (identifiable by excessive sooting on the decorative media), refer to the CLEANING AND MAINTENANCE section below.

## CLEANING & MAINTENANCE

- A. Always shut off the gas to the unit while performing service work.
- B. Allow the unit to cool before servicing.
- C. The unit should be inspected regularly. Excessive debris can build up on this unit from leaves, dirt, or other debris. It is critical that all control components, burners, burner screen, and the surrounding area be kept clean and free of all obstructions.

**Keep the surrounding area at the base of the unit clean and free of obstructions at all times.**

**Keep the screen on the burner pan clean and free of decorative media and other items that may cause obstruction.**

- D. The burner assembly must be replaced prior to the unit being put into operation if it is evident that the burner is damaged. Contact your local dealer for replacement parts.
- E. Periodically perform visual checks of the burner flames, and pilot flames (if applicable). The burner flames should be blue at the base with a combination of blue/yellow at the body and tips. The pilot (if applicable) should be a steady flame, touching the electrode/thermocouple. Contact a qualified service person for maintenance.

### **CAUTION**

**HOT DURING OPERATION AND AFTER USE. Children must be supervised when in the vicinity of this appliance. Serious injury may occur! Children must be alerted to the hazard of high surface temperatures and should stay away to avoid burns or clothing ignition.**



Keep vent openings (on bottom)  
clear for proper venting

**Fig. 25-1**

# PETERSON CAMPFYRE LIMITED WARRANTY

## THREE (3) YEAR LIMITED WARRANTY

All Peterson Outdoor Campfyre logs, enclosures, and burner component parts, (except valves and controls) are covered by a three (3) year limited warranty.

All Peterson valves and controls are covered by a separate one (1) year limited warranty (excluding batteries).

### PLEASE KEEP A COPY OF YOUR SALES SLIP FOR PROOF OF PURCHASE

This warranty applies to the original purchaser and to single family residential use only. It commences from date of purchase, and is valid only with proof of purchase.

This warranty does not cover parts becoming defective through misuse, accidental damage, electrical damage, improper handling, lack of routine maintenance, storage, and/or installation. Product must be installed (and gas must be connected) as specified in the instructions or operator's manual, by a **qualified professional installer**. Accessories, parts, valves, remotes, etc., when used must be Peterson Co. product.

This warranty **does not** apply to rust, corrosion, oxidation, or discoloration, unless the affected component becomes inoperable. It **does not** cover labor or labor-related charges.

This warranty specifically excludes liability for **indirect, incidental**, or consequential damages. Some states do not allow the exclusion or limitation of incidental or consequential damages, so the above exclusion may not apply to you. This warranty gives you specified legal rights, and you may have other rights that may vary from state to state.

For additional information regarding this warranty, or to place a warranty claim, contact the R.H. Peterson dealer where the product was purchased.

**TO REGISTER YOUR PRODUCT ONLINE GO TO: [WWW.RHPETERSON.COM](http://WWW.RHPETERSON.COM),  
AND CLICK ON PRODUCT REGISTRATION. THANK YOU FOR YOUR PURCHASE.**

| Quality Check   |       |       | Date: _____                  |                    |  |
|-----------------|-------|-------|------------------------------|--------------------|--|
| Burner Orifices | Nat.  | L.P.  | Leak Test: _____             | Model#: _____      |  |
| Main:           | _____ | _____ | Burn Test: _____             | Serial#: _____     |  |
| Other:          | _____ | _____ | Gas Type: <u>Nat. / L.P.</u> | Air Shutter: _____ |  |
|                 |       |       |                              | Inspector: _____   |  |