

**INSTALLER: THESE INSTRUCTIONS MUST BE CONVEYED TO AND REMAIN WITH THE HOMEOWNER.**

CERTIFIED UNDER CANADIAN AND AMERICAN NATIONAL STANDARDS, CR97-003, CAN1-2.21-M85, IAS U.S. 4-96.



**QUALITY FIREPLACES**

*Award Winning Products*

**OUTDOOR GAS APPLIANCE**

**INSTALLATION AND OPERATION INSTRUCTIONS FOR  
OUTDOOR GAS FIREPLACE**

NATURAL GAS *MODEL GSS36N*

PROPANE GAS *MODEL GSS36P*

CERTIFIED FOR CANADA AND UNITED STATES USING ANSI / CSA METHODS

**WARNING:** If the information in these instructions is not followed exactly, a fire or explosion may result causing property damage, personal injury or death.

**FOR YOUR SAFETY**

Do not store or use gasoline or other flammable vapours and liquids in the vicinity of this or any other appliance.

**WHAT TO DO IF YOU SMELL GAS:**

- Do not try to light any appliance.
- Do not touch any electrical switch.
- Close propane bottle or shut-off gas supply.
- Do not use any phone in your building or near the appliance.
- Immediately call your gas supplier from a neighbour's phone. Follow the gas supplier's instructions.
- If you cannot reach your gas supplier, call the fire department.

Installation and service must be performed by a qualified installer, service agency or the gas supplier.

**THIS FIREPLACE MUST BE INSTALLED OUTSIDE.**



Wolf Steel Ltd., 24 Napoleon Rd., Barrie, ON L4M 4Y8 Canada • (705)721-1212 • fax(705)722-6031

[www.napoleonfireplaces.com](http://www.napoleonfireplaces.com) • [ask@napoleon.on.ca](mailto:ask@napoleon.on.ca)

## TABLE of CONTENTS

### PG 3-4 INTRODUCTION

Warranty  
General Instructions  
General Information

### 5-6 INSTALLATION

Gas Installation  
Combustion and Ventilation Air Provisions  
Clearance to Combustibles  
Framing  
Mantle Clearances  
Nailing Tab Installation

### 7-8 FINISHING

Log Placement  
Curtain Mesh  
Hood Installation  
Logo Placement  
Louvre Installation

### 9 OPERATION / MAINTENANCE

Operating Instructions  
Maintenance  
Venturi Adjustment

### 10 REPLACEMENTS

Ordering Replacement Parts  
Replacement Parts

### 11-12 TROUBLE SHOOTING GUIDE

## PLEASE RETAIN THIS MANUAL FOR FUTURE REFERENCE

### WARNING

- Under no circumstances should this fireplace be modified.
- Provide adequate ventilation and combustion air. Provide adequate accessibility clearance for servicing and operating the fireplace. Never obstruct the front opening of the fireplace.
- If fireplace keeps shutting off, have it serviced. Keep burner and control compartment clean.
- Do not burn wood or other materials in this fireplace.
- Adults and especially children should be alerted to the hazards of high surface temperatures and should stay away to avoid burns or clothing ignition. Supervise young children when they are in the vicinity of the fireplace.
- Clothing or other flammable material should not be placed on or near the fireplace.
- Any safety screen or guard removed for servicing must be replaced prior to operating the fireplace.
- It is imperative that the control compartments, burners and circulating air passageways in the fireplace are kept clean. The fireplace should be inspected before use and at least annually by a qualified service person. The fireplace area must be kept clear and free from combustible materials, gasoline and other flammable vapours and liquids.
- Furniture or other objects must be kept a minimum of 4 feet away from the front of the fireplace.
- Do not use this fireplace if any part has been under water. Immediately call a qualified service technician to inspect the fireplace and to replace any part of the control system and any gas control which has been under water.
- Do not allow wind to blow directly into the fireplace. Avoid any drafts that alter burner flame patterns.
- Do not use any accessory not approved for use with this fireplace.

***ANY CHANGE TO THIS FIREPLACE OR ITS CONTROLS CAN BE DANGEROUS  
AND IS PROHIBITED.***

NOTE: Changes, other than editorial, are denoted by a vertical line in the margin.

*NAPOLEON products are manufactured under the strict Standard of the world recognized  
ISO 9001 : 2000 Quality Assurance Certificate.*

*NAPOLEON products are designed with superior components and materials, assembled by trained craftsmen who take great pride in their work. The burner and valve assembly are leak and test-fired at a quality test station. Once assembled the complete appliance is thoroughly inspected by a qualified technician before packaging to ensure that you, the customer; reviews the quality product that you expect from NAPOLEON.*

### **NAPOLEON GAS APPLIANCE 5 YEAR LIMITED WARRANTY**

*All stainless steel components of your new Napoleon gas appliance are warranted against defects for five years.*

*All parts such as gas valves, logs, gasketing are covered and Napoleon will provide replacement parts free of charge during the first year of the limited warranty.*

*Labour related to warranty repair is covered free of charge during the first year. Repair work, however, requires the prior approval of an authorized company official. Labour costs to the account of NAPOLEON are based on a predetermined rate schedule and any repair work must be done through an authorized NAPOLEON dealer.*

### **CONDITIONS AND LIMITATIONS**

NAPOLEON warrants its products against manufacturing defects to the original purchaser only -- i.e., the individual or legal entity (registered customer) whose name appears on the warranty registration card filed with NAPOLEON -- provided that the purchase was made through an authorized NAPOLEON dealer and is subject to the following conditions and limitations:

This limited warranty applies only while the unit remains at the site of original installation, and only if the unit is installed in Canada or the United States.

This factory warranty is nontransferable and may not be extended whatsoever by any of our representatives.

Installation must be done in accordance with the installation instructions included with the product and all local and national building and fire codes.

This limited warranty does not cover damages caused by misuse, lack of maintenance, accident, alterations, abuse or neglect and parts installed from other manufacturers will nullify this warranty.

This limited warranty further does not cover any scratches, dents, corrosion or discolouring caused by excessive heat, abrasive and chemical cleaners, mechanical breakage of logs and embers.

In the first year only, this warranty extends to the repair or replacement of warranted parts which are defective in material or workmanship provided that the product has been operated in accordance with the operation instructions and under normal conditions.

After the first year, with respect to this Limited Warranty, NAPOLEON may, at its discretion, fully discharge all obligations with respect to this warranty by refunding to the original warranted purchaser the wholesale price of any warranted but defective part(s).

After the first year, NAPOLEON will not be responsible for installation, labour or any other costs or expenses related to the reinstallation of a warranted part, and such expenses are not covered by this warranty.

Notwithstanding any provisions contained in this Limited Warranty, NAPOLEON'S responsibility under this warranty is defined as above and it shall not in any event extend to any incidental, consequential or indirect damages.

This warranty defines the obligations and liability of NAPOLEON with respect to the NAPOLEON gas appliance and any other warranties expressed or implied with respect to this product, its components or accessories are excluded.

This limited warranty does not cover damages resulting from the use of components not supplied with the appliance, or the use of fuel other than those specified.

Any damages to appliance due to weather, long periods of dampness, condensation, damaging chemicals or cleaners will not be the responsibility of NAPOLEON.

The bill of sale or copy will be required together with a serial number and a model number when making any warranty claims from your authorized dealer. The warranty registration card must be returned within fourteen days to register the warranty.

NAPOLEON reserves the right to have its representative inspect any product or part thereof prior to honouring any warranty claim.

## GENERAL INSTRUCTIONS

**THIS GAS FIREPLACE SHOULD BE INSTALLED AND SERVICED BY A QUALIFIED INSTALLER** to conform with local codes. Installation practices vary from region to region and it is important to know the specifics that apply to your area.

The installation must conform with Local codes or in the absence of local codes, with the National Fuel Gas Code ANSI Z223.1/INFPA 54 in the United States or CSA B149.1, Natural and Propane Installation code in Canada.

The fireplace and its individual shutoff valve must be disconnected from the gas supply piping system during any pressure testing of that system at test pressures in excess of 1/2 psig (3.5 kPa). The fireplace must be isolated from the gas supply piping system by closing its individual manual shutoff valve during any pressure testing of the gas supply piping system at test pressures equal to or less than 1/2 psig (3.5 kPa).

When the fireplace is installed directly on combustible material other than wood flooring, the fireplace shall be installed on a metal or wood panel extending the full width and depth.



## GENERAL INFORMATION

**FOR YOUR SATISFACTION, THIS FIREPLACE HAS BEEN TEST-FIRED TO ASSURE ITS OPERATION AND QUALITY!** Maximum input is 40,000 BTU/hr for natural gas and propane. When the fireplace is installed at elevations above 2,000ft, and in the absence of specific recommendations from the local authority having jurisdiction, the certified high altitude input rating shall be reduced at the rate of 4% for each additional 1,000ft.

*It is highly recommended to protect the logs from moisture (rain, snow). Cover the firebox when not in use.*

*This fireplace is only for use with the type of gas indicated on the rating plate. This fireplace is not convertible for use with other gases, unless a certified kit is used.*

Minimum inlet gas supply pressure is 4.5 inches water column for natural gas and 11 inches water column for propane. Maximum inlet gas pressure is 7 inches water column for natural gas and 13 inches water column for propane. Manifold pressure under flow conditions is 3.5 inches water column for natural gas and 10 inches water column for propane.

**No external electricity (110 volts or 24 volts) is required for the gas system operation.**

Expansion / contraction noises during heating up and cooling down cycles are normal and are to be expected.

**Use only accessories designed for and listed with your specific fireplace.**

## DIMENSIONS

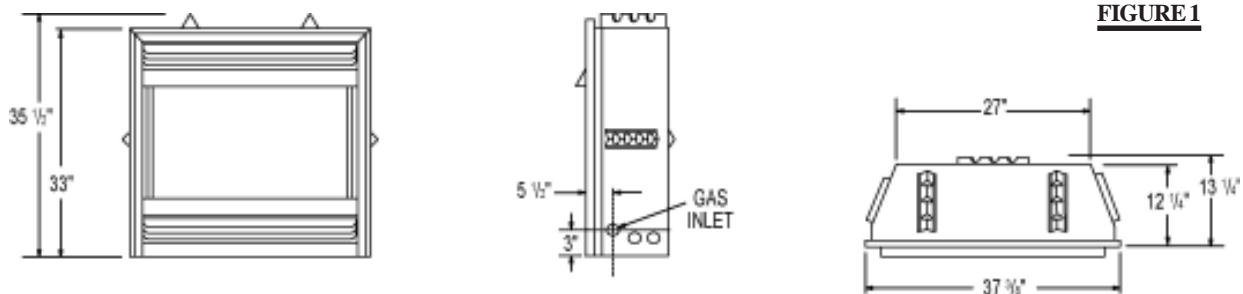

# INSTALLATION

## GAS INSTALLATION

**NOTE:** If the unit is installed using a propane cylinder as a source of fuel, the cylinder must be retained. A stand for a standard 20lb cylinder is available from your Napoleon Dealer.

1. Move the fireplace into position and secure using the nailing tabs and/or secure to the floor through the 1/4"Ø holes located at either end of the base.

2. Install rigid black pipe, 1/2" type-L copper tubing or, if local codes permit, a 3/8" flex connector and shutoff valve to the gas line and the fireplace gas valve. Seal and tighten securely. An adapter fitting is required between the gas valve and the copper tubing or flex connector.

**DO NOT KINK FLEX CONNECTOR.**

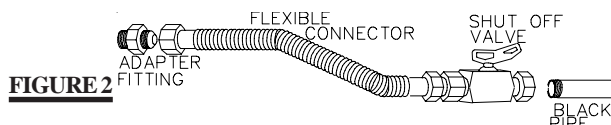

3. Check for gas leaks by brushing on a soap and water solution.

**DO NOT USE OPEN FLAME.**

4. For ease of accessibility, an optional remote wall switch may be installed in a convenient location. Route a 2 strand, solid core millivolt wire through the electrical hole located at the bottom left side of the unit. The recommended maximum lead length depends on wire size:

WIRE SIZE	MAX. LENGTH
14gauge	100 feet
16gauge	60 feet
18gauge	40 feet

Attach the two leads to terminals 1 and 3 located on the gas valve.

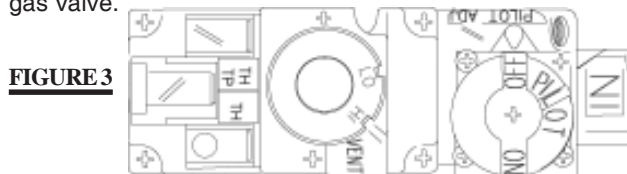

**Do not connect either the wall switch, thermostat or gas valve to electricity (110 volts).**

## COMBUSTION & VENTILATION AIR

This fireplace is intended for installation on an outdoor patio or in your yard. It must never be installed inside the warm air envelope of your structure.

It is highly recommended that this fireplace be installed in a "sheltered" area. Direct wind will cause an erratic flame and possible pilot or main burner outage.

An erratic flame could also lead to excessive carboning (black soot), this condition is not a safety issue but is visually undesirable.

Typical installation may include covered patio, screened porch, gazebo or an outside the wall of a house.\*

**NOTE:** Ensure the area has adequate ventilation.

**FIGURE 4**



## CLEARANCE TO COMBUSTIBLES

Sides, back, bottom & top	0 inches
Recessed	13¾ inches
Top of unit to ceiling	48"

It is recommended that the walls of the fireplace enclosure be finished. This would ensure that clearance to combustibles is maintained within the cavity.

**\* If installing a propane fireplace the propane cylinder must always be on the exterior of such a structure.**

## FRAMING

It is best to frame your fireplace after it is positioned. Use 2x4's and frame to local building codes. **FIGURE 4-6.**

**FIGURE 5**

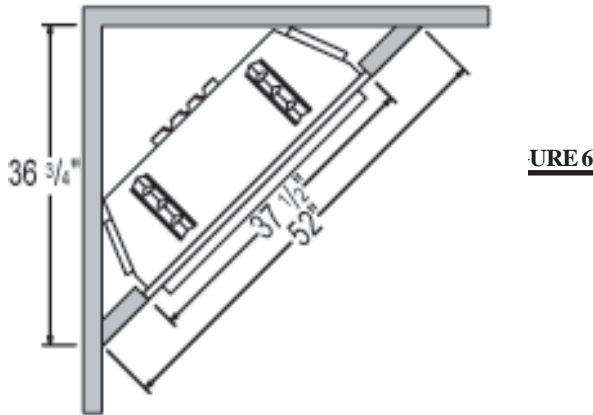
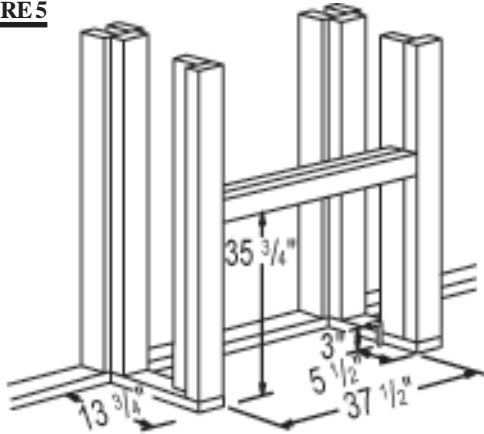

**FIGURE 6**

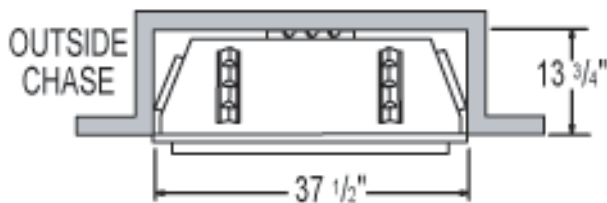

**FIGURES 7**

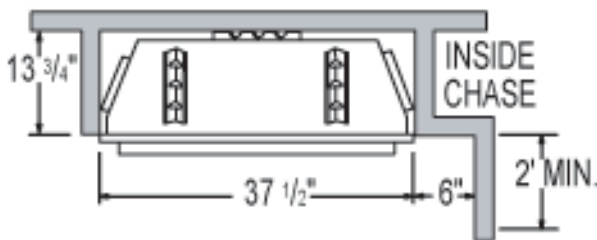

Combustible materials may be installed flush with the front of the fireplace but must not cover any of the black face-areas of the fireplace. Non-combustible material (brick, stone or ceramic tile) may protrude in these areas. It is not necessary to install a hearth extension with this fireplace system.

When roughing in the fireplace, raise the fireplace to accommodate for the thickness of the finished floor materials, i.e. tile, carpeting, hard wood, which if not planned for will interfere with the opening of the lower access door and the installation of many decorative flashing accessories.

Objects placed in front of the fireplace should be kept a minimum of 4 feet away from the front face.

## MANTLE CLEARANCES

Combustible mantle clearance can vary according to the mantle depth. Use the graph to help evaluate the clearance needed.

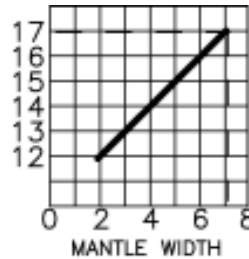
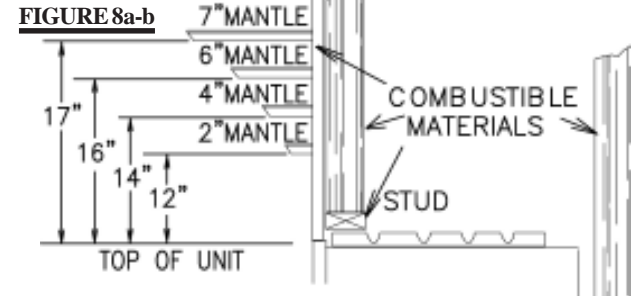

**FIGURE 9**

## NAILING TAB INSTALLATION

To install the fireplace face flush with the finished surface, position the framework to accommodate the thickness of the finished surface. Bend out the four nailing tabs, attached on either side of the fireplace and secure to the 2x4 framing. The tabs will facilitate the installation of either a 3/4" or a 1" finished surface thickness. *The nailing tabs must not be removed.*



**FIGURE 10**

## FINISHING

### LOG PLACEMENT

**PHAZER™** logs are exclusive to Napoleon Fireplaces, provide a unique and realistic glowing effect that is different in every installation.

Log colours may vary. During the initial use of the fireplace, the colours will become more uniform as colour pigments burn in during the heat activated curing process.

**FIGURE 11a-d**



**1.** Place the back log (#1) onto the log support tray and in front of the tabs. The tabs maintain an air space between the log and firebox back to facilitate combustion air flow. Ensure that the back of the log rests against the brackets on the back wall of the firebox.



**2.** Move the two small logs (#2 & #3) into position, lining up the studs located on the burner with the holes on the bottom of the logs. Ensure that the small logs sit flat on the burner.



**3.** Place the bottom of the left crossover log (#4) against the left firebox side and pulled forward to the grate.



The top of the log should rest in the pocket on the back log.

**4.** Position the notch located on the end of the center log (#5) against the middle grate post with the other end of the



log resting in the pocket of the left crossover log.

**5.** Place the bottom of the right crossover log (#6) against the right firebox side and pulled forward to the grate. The top of the log should rest in the pocket provided on the center log (#5).

Blocked burner ports can cause an incorrect flame pattern, carbon deposits and delayed ignition. **PHAZER™** logs glow when exposed to direct flame. **PHAZER™** logs available from your Napoleon dealer.

### IMPORTANT

**IT IS HIGHLY RECOMMENDED TO PROTECT THE LOGS FROM MOISTURE.  
COVER THE FIREBOX WHEN NOT IN USE.**

**HOOD**

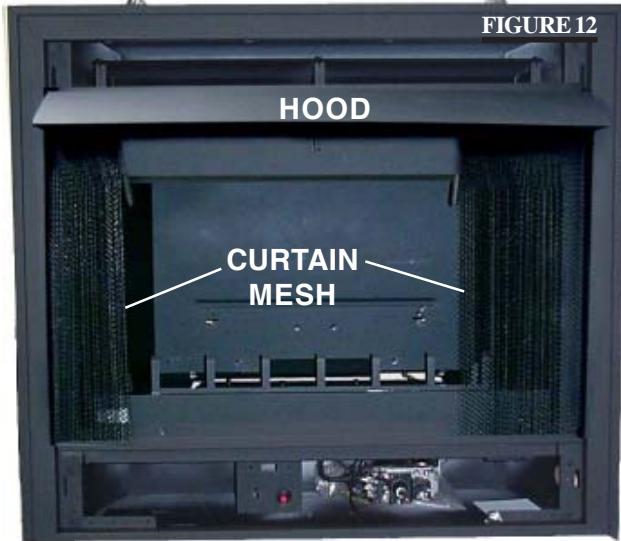

The curtain mesh must be kept fully closed during operation to help prevent accidental burns from occurring.



*The heater must not be used when the hood is removed.* Hook the hood over the lip of the curtain support plate.

**LOGO PLACEMENT**

Remove the backing of the logo supplied and place on the screen cover, as indicated.

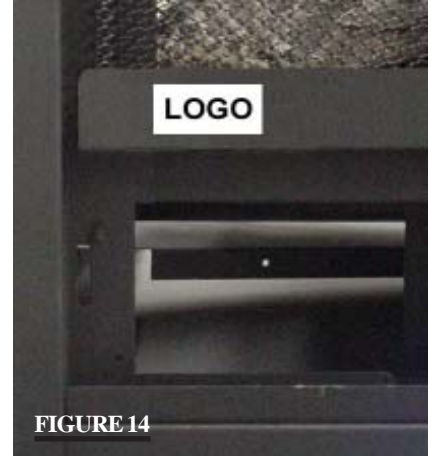

**LOUVRE INSTALLATION**

**FIGURE 15a-c**

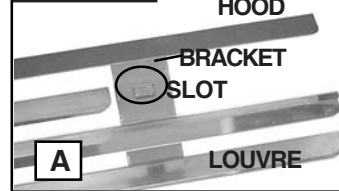

**UPPER LOUVRES:** Insert the upper louvres into the slots on both brackets. Press the top flange of the hood into the four clips located along the top of the unit as shown.

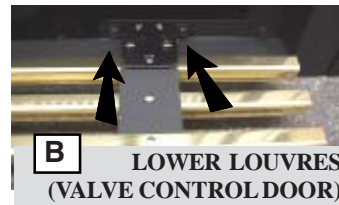

**LOWER LOUVRES:** Attach each hinge to the firebox with 2 screws.

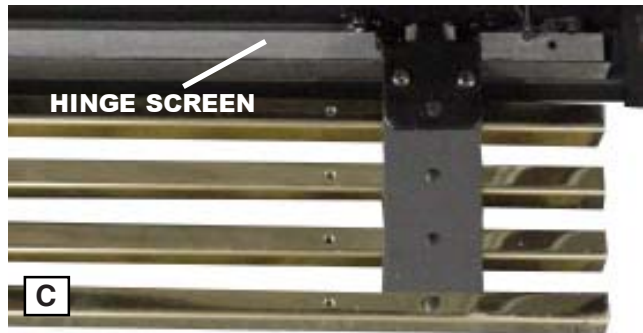

**HINGE SCREEN:** Position the hinge screen into place and with the control door open, secure to the firebox using three screws.

## OPERATION / MAINTENANCE

*If heater keeps shutting off, have it serviced. Keep burner and control compartment clean.*

*When lit for the first time, the fireplace will emit a slight odour for a few hours. This is a normal temporary condition caused by the curing of the logs and the "burn-in" of internal paints and lubricants used in the manufacturing process and will not occur again.*

*After extended periods of non-operation such as following a vacation or a warm weather season, the fireplace may emit a slight odour for a few hours. This is caused by dust particles burning off.*

### FOR YOUR SAFETY READ BEFORE LIGHTING:

- A.** This fireplace is equipped with a pilot which must be lit by hand while following these instructions exactly.
- B.** Before operating smell all around the fireplace area for gas and next to the floor because some gas is heavier than air and will settle on the floor.
- C.** Use only your hand to turn the gas control knob / manual shut-off knob. Never use tools. If the knob will not turn by hand, do not try to repair it. Call a qualified service technician. Force or attempted repair may result in a fire or explosion.
- D.** Do not use this fireplace if any part has been under water. Immediately call a qualified service technician to inspect the fireplace and replace any part of the control system and any gas control which has been under water.

### WHAT TO DO IF YOU SMELL GAS

- Do not use a mobile or land phone.
- If you cannot reach your gas supplier, call the fire department.
- Turn off all gas to the fireplace.
- Do not try to light any appliance.
- Immediately call your gas supplier from a neighbour's phone. Follow the gas supplier's instructions.



## MAINTENANCE

**CAUTION:** Label all wires prior to disconnection when servicing controls. Wiring errors can cause improper and dangerous operation. Verify proper operation after servicing. This heater should be inspected and serviced before use and at least annually by a qualified service person. The fireplace area must be kept clear and free of combustible materials, gasoline or other flammable vapours and liquids. The flow of combustion and ventilation air must not be obstructed.

- 2.** Keep the control compartment, logs, burner, air shutter opening and the area surrounding the logs clean by vacuuming or brushing, *at least once a year.*
- 3.** Check to see that all burner ports are burning. Clean out any of the ports which may not be burning or are not burning properly.
- 4.** Check to see that the pilot flame is large enough to engulf the thermocouple and thermopile and promptly ignites the main burner.
- 6.** Check to see that the main burner ignites completely on all openings when the gas knob for the burner is turned on. A 5 to 10 second total light-up period is satisfactory. If ignition takes longer, consult your Napoleon dealer / distributor.

### LIGHTING INSTRUCTIONS

When lighting and re-lighting, the gas knob cannot be turned from pilot to off unless the knob is depressed.

1. **Stop!** Read the safety information on the operating label.
2. Turn the gas knob clockwise  to off.
3. Wait five (5) minutes to clear out any gas. If you smell gas including near the floor, **stop!** Follow "b" on the operating label. If you don't smell gas go to the next step.
4. If fireplace is equipped with flame adjustment valve turn clockwise to off.
5. Find pilot located in front of back log.
6. Turn gas knob counter-clockwise  to pilot.
7. Depress and hold gas knob while lighting the pilot with the push button ignitor. Keep knob fully depressed for one minute, then release. If pilot does not continue to burn repeat steps 3 through 7.
8. With pilot lit, turn gas knob counter-clockwise  to on.
9. If equipped with flame adjustment valve, push and turn knob to high.
10. If equipped with remote on-off switch, main burner may not come on when you turn the valve to on or high. Remote switch must be in the on position to ignite burner.

### TO TURN OFF GAS

- Push in gas control knob slightly and turn clockwise  to off. Do not force.

**Cleaning Stainless Steel:** Do not use abrasive cleaners to clean any painted, porcelain or stainless steel parts. To clean stainless surfaces, use a stainless steel cleaner or a non-abrasive cleaner. Always wipe in the direction of the grain. Do not use steel wool, as it will scratch the finish. Stainless steel parts will discolour when heated, usually to a golden or brown colour. This discolouration is normal and will not affect the performance of the appliance.

## VENTURI ADJUSTMENT

**Air shutter adjustment must only be done by a qualified gas installer!**

Closing the air shutter will cause a more yellow flame, but can lead to carboning. Opening the air shutter will cause a more blue flame, but can cause flame lifting from the burner ports. The flame may not appear yellow immediately; allow 15 to 30 minutes for the final flame colour to be established. Opening the air shutter will also reduce exhaust odours. See *Trouble Shooting Guide*.

AIR SHUTTER OPENINGS	
NG	7/16"
LP	FULLY OPEN

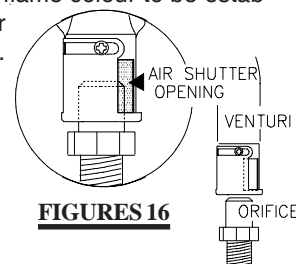

FIGURES 16

# REPLACEMENTS

Contact your dealer for questions concerning prices and policies on replacement parts. Normally all parts can be ordered through your Napoleon dealer or distributor.

When ordering replacement parts always give the following information:

1. MODEL & SERIAL NUMBER OF FIREPLACE
2. INSTALLATION DATE OF FIREPLACE
3. PART NUMBER
4. DESCRIPTION OF PART
5. FINISH

**FOR WARRANTY REPLACEMENT PARTS, A PHOTOCOPY OF THE ORIGINAL INVOICE WILL BE REQUIRED TO HONOUR THE CLAIM.**

*\* IDENTIFIES ITEMS WHICH ARE NOT ILLUSTRATED. FOR FURTHER INFORMATION, CONTACT YOUR NAPOLEON DEALER.*

## REPLACEMENT PARTS

#	PART NO.	DESCRIPTION
1	W357-0001	PIEZO IGNITER
2	W680-0004	THERMOPILE
3	*W680-0005	THERMOCOUPLE
4	W010-0800	NATURAL GAS PILOT ASSEMBLY
4	W010-0801	PROPANE GAS PILOT ASSEMBLY
5	W455-0069	NATURAL GAS PILOT INJECTOR
5	W455-0067	PROPANE GAS PILOT INJECTOR
6	W725-0028	NATURAL GAS VALVE
6	W725-0029	PROPANE GAS VALVE
7*	W385-0245	NAPOLEON LOGO
8	GL-639OD	LOG SET
11	W135-0183OD	BACK LOG (#1)
12	W135-0184OD	LEFT MIDDLE LOG (#2)
13	W135-0185OD	RIGHT MIDDLE LOG (#3)
14	W135-0186OD	LEFT CROSSOVER LOG (#4)
15	W135-0187OD	MIDDLE CROSSOVER LOG (#5)
16	W135-0188OD	RIGHT CROSSOVER LOG (#6)
17	W010-1066	PAN BURNER
18	W455-0078	#31 NATURAL GAS BURNER ORIFICE
18	W455-0042	#49 PROPANE GAS BURNER ORIFICE
19	W335-0033	HOOD
20	W565-0062	CURTAIN MESH
21	W555-0040	CURTAIN ROD
22*	W080-0614	CURTAIN ROD BRACKET
23	W500-0209	CURTAIN SUPPORT PLATE
24	W630-0010	BLACK TASSELS
25	W200-0135	FIREBOX COVER
26	N325-0036	COVER HANDLE
28*	W660-0005	SWITCH
29*	W750-0109	3/16" FLAG WIRE ASSEMBLY
30*	W750-0110	1/4" FLAG WIRE ASSEMBLY

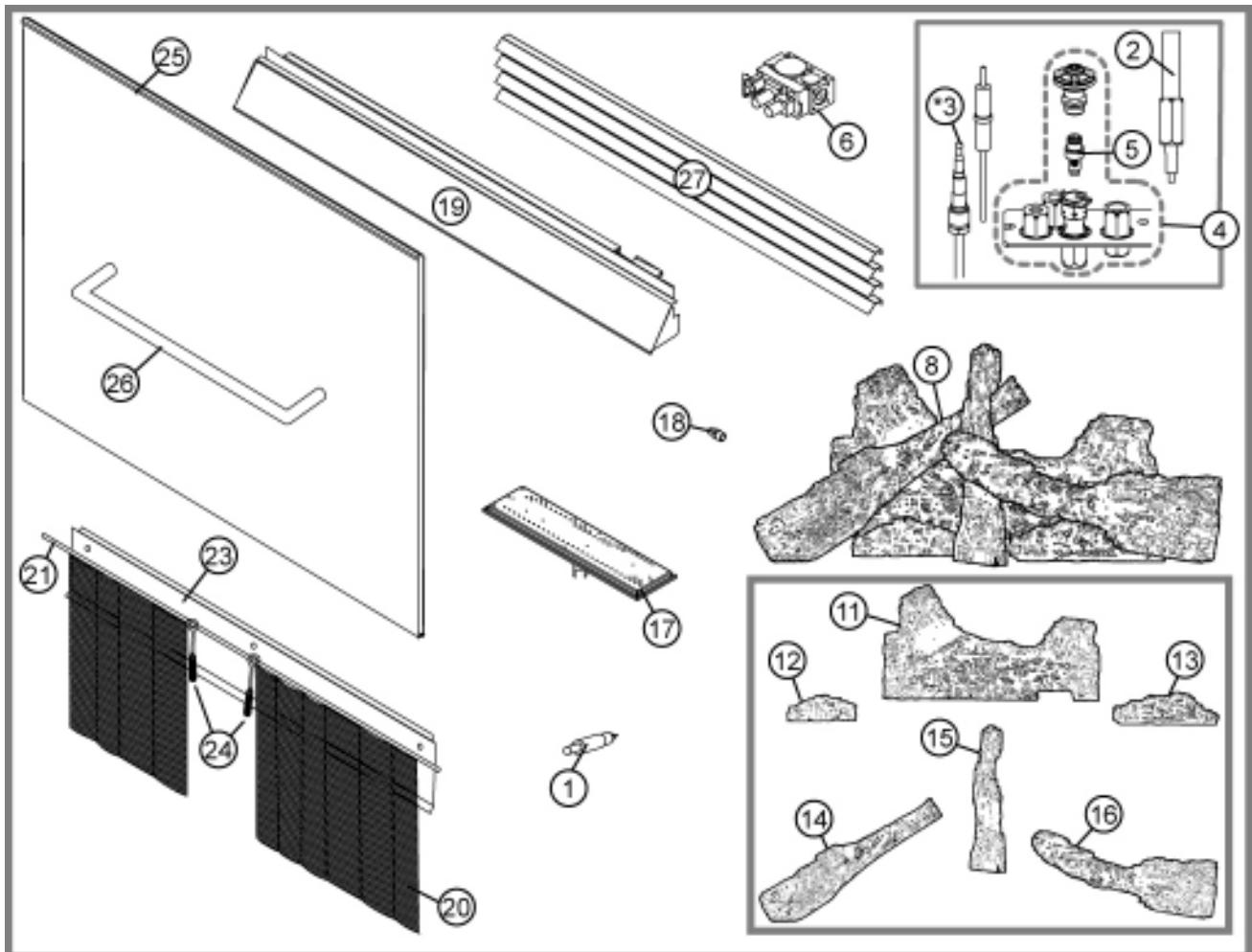

**\* WARNING: This is a fast acting thermocouple. It is an integral safety component. Replace only with a fast acting thermocouple supplied by Wolf Steel Ltd.**

# TROUBLE SHOOTING GUIDE

SYMPTOM	PROBLEM	TEST SOLUTION	
Main burner goes out; pilot stays on.	Pilot flame is not large enough or not engulfing the thermopile	<ul style="list-style-type: none"> <li>- turn up pilot flame.</li> <li>- replace pilot assembly.</li> </ul>	
	Thermopile shorting	<ul style="list-style-type: none"> <li>- clean thermopile connection to the valve. Reconnect.</li> <li>- replace thermopile / valve.</li> </ul>	
	Remote wall switch wire is too long; too much resistance in the system.	<ul style="list-style-type: none"> <li>- shorten wire to correct length or wire gauge.</li> </ul>	
	Faulty thermostat or switch.	<ul style="list-style-type: none"> <li>- replace.</li> </ul>	
Pilot goes out when the gas knob is released.  <b>The gas valve has an interlock device which will not allow the pilot burner to be lit until the thermocouple has cooled. Allow approximately 60 seconds for the thermocouple to cool.</b>	System is not correctly purged.	<ul style="list-style-type: none"> <li>- purge the gas line.</li> </ul>	
	Out of propane gas.	<ul style="list-style-type: none"> <li>- fill the tank.</li> </ul>	
	Pilot flame is not large enough	<ul style="list-style-type: none"> <li>- turn up the pilot flame.</li> </ul>	
	Pilot flame is not engulfing the thermocouple.	<ul style="list-style-type: none"> <li>- gently twist the pilot head to improve the flame pattern around the thermocouple.</li> </ul>	
	Thermocouple shorting / faulty.	<ul style="list-style-type: none"> <li>- loosen and tighten thermocouple.</li> <li>- clean thermocouple and valve connection.</li> <li>- replace thermocouple.</li> <li>- replace valve.</li> </ul>	
Faulty valve.	<ul style="list-style-type: none"> <li>- replace.</li> </ul>		
Pilot burning; no gas to main burner; gas knob is on 'HI'; wall switch / thermostat is on.	Thermostat or switch is defective.	<ul style="list-style-type: none"> <li>- connect a jumper wire across the wall switch terminals; if main burner lights, replace switch / thermostat.</li> </ul>	
	Wall switch wiring is defective.	<ul style="list-style-type: none"> <li>- disconnect the switch wires &amp; connect a jumper wire across terminals 1 &amp; 3; if the main burner lights, check the wires for defects and / or replace wires.</li> </ul>	
	Main burner orifice is plugged.	<ul style="list-style-type: none"> <li>- remove stoppage in orifice.</li> </ul>	
	Faulty valve.	<ul style="list-style-type: none"> <li>- replace.</li> </ul>	
Pilot will not light.	No spark at pilot burner	<ul style="list-style-type: none"> <li>- check if pilot can be lit by a match</li> <li>- check that the wire is connected to the push button ignitor.</li> <li>- check if the push button ignitor needs tightening.</li> <li>- replace the wire if the wire insulation is broken or frayed.</li> <li>- replace the electrode if the ceramic insulator is cracked or broken.</li> <li>- replace the push button ignitor.</li> </ul>	
		Out of propane gas	<ul style="list-style-type: none"> <li>- fill the tank.</li> </ul>
		Spark gap is incorrect	<ul style="list-style-type: none"> <li>- spark gap should be 0.150" to 0.175" (5/32" to 11/64" approx.) from the electrode tip and the pilot burner. To ensure proper electrode location, tighten securing nut (finger tight plus 1/4 turn).</li> </ul>
		No gas at the pilot burner	<ul style="list-style-type: none"> <li>- check that the manual valve is turned on.</li> <li>- check the pilot orifice for blockage.</li> <li>- replace the valve.</li> <li>- call the gas distributor.</li> </ul>

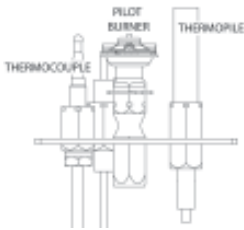

SYMPTOM	PROBLEM	TEST SOLUTION
Pilot goes out while standing; Main burner is in 'OFF' position.	Gas piping is undersized.  High Wind.	<ul style="list-style-type: none"> <li>- turn on all gas appliances and see if pilot flame flutters, diminishes or extinguishes, especially when main burner ignites. Monitor appliance supply working pressure.</li> <li>- check if supply piping size is to code. Correct all undersized piping.</li> <li>- unit has been exposed to a high wind condition.</li> </ul> <p>A "sheltered" area is recommended for the installation location.</p> <ul style="list-style-type: none"> <li>- close mesh screens.</li> </ul>
Flames are consistently too large or too small. Carboning occurs.	Unit is over-fired or under-fired.	<ul style="list-style-type: none"> <li>- check pressure readings:</li> </ul> <p>Inlet pressure can be checked by turning screw (A) counter-clockwise 2 or 3 turns and then placing pressure gauge tubing over the test point. Gauge should read 7" (minimum 4.5") water column for natural gas or 13" (11" minimum) water column for propane. Check that main burner is operating on "HI".</p> <p>Outlet pressure can be checked the same as above using screw (B). Gauge should read 3.5" water column for natural gas or 10" water column for propane. Check that main burner is operating on "HI".</p> <p><b>AFTER TAKING PRESSURE READINGS, BE SURE TO TURN SCREWS CLOCKWISE FIRMLY TO RESEAL. DO NOT OVERTORQUE.</b></p> <p>Leak test with a soap and water solution.</p>
Carbon is being deposited on, logs or combustion chamber surfaces.	Air shutter has become blocked  Flame is impinging on the logs or combustion chamber.	<ul style="list-style-type: none"> <li>- ensure air shutter opening is free of lint or other obstructions.</li> </ul> <hr/> <ul style="list-style-type: none"> <li>- check that the logs are correctly positioned.</li> <li>- open air shutter to increase the primary air.</li> <li>- check the input rate: check the manifold pressure and orifice size as specified by the rating plate values.</li> <li>- close mesh screens.</li> </ul>
Remote wall switch is in "OFF" position; main burner comes on when gas knob is turned to "ON" position.	Wall switch is mounted upside down Remote wall switch is grounding. Remote wall switch wire is grounding. Faulty valve.	<ul style="list-style-type: none"> <li>- reverse.</li> </ul> <hr/> <ul style="list-style-type: none"> <li>- replace.</li> </ul> <hr/> <ul style="list-style-type: none"> <li>- check for ground (short); repair ground or replace wire.</li> </ul> <hr/> <ul style="list-style-type: none"> <li>- replace.</li> </ul>

