

Installation Manual

Installation and Appliance Setup

INSTALLER: Leave this manual with party responsible for use and operation.
OWNER: Retain this manual for future reference.

NOTICE: DO NOT discard this manual!

outdoor
lifestyles
by hearth & home technologies®

Models:

CARODG36I-C
CARODG42I-C

GAS-FIRED

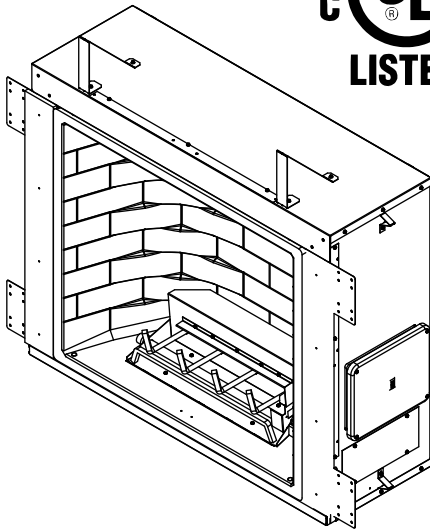

⚠ DANGER

If you smell gas:

1. Shut off gas to the appliance.
2. Extinguish any open flame.
3. If odor continues, keep away from the appliance and immediately call your gas supplier or fire department.

⚠ WARNING: For Outdoor Use Only.

⚠ WARNING

Do not store or use gasoline or other flammable vapors and liquids in the vicinity of this or any other appliance.

An LP-cylinder not connected for use shall not be stored in the vicinity of this or any other appliance.

⚠ WARNING! Risk of Fire!

Do not install glass doors on this fireplace.
Glass doors could cause overheating of adjacent structures.

⚠ WARNING: Improper installation, adjustment, alteration, service or maintenance can cause injury or property damage. Read the installation, operating and maintenance instructions thoroughly before installing or servicing this equipment.

⚠ DANGER



CARBON MONOXIDE HAZARD

This appliance can produce carbon monoxide which has no odor.

Using it in an enclosed space can kill you.

Never use this appliance in an enclosed space such as a camper, tent or home.

▲ Safety Alert Key:

- **DANGER!** Indicates a hazardous situation which, if not avoided will result in death or serious injury.
- **WARNING!** Indicates a hazardous situation which, if not avoided could result in death or serious injury.
- **CAUTION!** Indicates a hazardous situation which, if not avoided, could result in minor or moderate injury.
- **NOTICE:** Used to address practices not related to personal injury.

Table of Contents

Installation Standard Work Checklist	3
--	---

1 Product Specific and Important Safety Information

A. Appliance Certification	4
B. BTU Specifications	4
C. High Altitude Installations	4
D. Non-Combustible Materials Specification	4
E. Combustible Materials Specification	4
F. Electrical Codes	4
G. Fuel	4

2 Getting Started

A. Design and Installation Considerations	5
B. Tools and Supplies Needed	5
C. Inspect Appliance and Components	6

3 Framing and Clearances

A. Appliance/Decorative Front Dimension Diagrams	7
B. Clearances to Combustibles	9
C. Hearth Extension/Floor Protection	12
D. Stand-Alone Installation	12
E. Built-in Installation	12
F. Moisture Resistance	12

4 Appliance Preparation

A. Securing and Leveling Appliance	13
B. Flashing	13

5 Electrical Information

A. General Information	14
B. Wiring Requirements	14
C. Installing the Electric Kit	15

6 Gas Information

A. Fuel Conversion	18
B. Gas Pressure	18
C. Gas Connection	18
D. Valve Access	20
E. High Altitude Installations	20

7 Finishing

A. Facing Material	21
B. Mantel and Wall Projections	21

8 Appliance Setup

A. Remove the Shipping Materials	22
B. Inspect Firebox	22
C. Clean the Appliance	22
D. Optional Accessories	22
E. Install Pilot Shield	22
F. Install Lava Rock	22
G. Install the Log Assembly	23
H. Place Remaining Lava Rock	24
I. Install Firescreen	25

9 Reference Materials

A. Accessories	26
--------------------------	----

➔ = Contains updated information.

Installation Standard Work Checklist

ATTENTION INSTALLER: Follow this Standard Work Checklist

This standard work checklist is to be used by the installer in conjunction with, not instead of, the instructions contained in this installation manual.

Customer: _____
Lot/Address: _____
Model (circle one): CARODG36I-C
 CARODG42I-C

Date Installed: _____
Location of Fireplace: _____
Installer: _____
Dealer/Distributor Phone # _____
Serial #: _____

 **WARNING! Risk of Fire or Explosion!** Failure to install appliance according to these instructions could lead to a fire or explosion.

Appliance Install

	YES	IF NO, WHY?
Verified that the enclosure is insulated or sealed. (Pg. 12)	<input type="checkbox"/>	_____
Required non-combustible materials are installed. (Pg. 12)	<input type="checkbox"/>	_____
Verified clearances to combustibles. (Pg. 9-12)	<input type="checkbox"/>	_____
Fireplace is leveled and secured. (Pg. 13)	<input type="checkbox"/>	_____

Electrical Section 5 (Pg. 14-17)

Unswitched power (110-120 VAC) provided to the appliance.	<input type="checkbox"/>	_____
Switch wires properly installed.	<input type="checkbox"/>	_____

Gas Section 6 (Pg.18-20)

Proper appliance for fuel type.	<input type="checkbox"/>	_____
Was a conversion performed?	<input type="checkbox"/>	_____
Leak check performed and inlet pressure verified.	<input type="checkbox"/>	_____

Finishing Section 7 (Pg. 21)

Combustible materials not installed in non-combustible areas.	<input type="checkbox"/>	_____
Verified all clearances meet installation manual requirements.	<input type="checkbox"/>	_____
Mantels and wall projections comply with installation manual requirements.	<input type="checkbox"/>	_____

Appliance Setup Section 8 (Pg. 22-25)

All packaging and protective materials removed (inside & outside of appliance).	<input type="checkbox"/>	_____
Logs and lava rock installed correctly.	<input type="checkbox"/>	_____
Firescreen front properly installed.	<input type="checkbox"/>	_____
Manual bag and all of its contents are removed from inside/under the appliance and given to party responsible for use and operation.	<input type="checkbox"/>	_____
Started appliance and verified no gas leaks exist.	<input type="checkbox"/>	_____

Hearth & Home Technologies recommends the following:

- Photographing the installation and copying this checklist for your file.
- That this checklist remain visible at all times on the appliance until the installation is complete.

Comments: Further description of the issues, who is responsible (Installer/ Builder/ Other Trades, etc) and corrective action needed _____

Comments Communicated to party responsible _____ by _____ on _____
 (Builder / Gen. Contractor/) (Installer) (Date)

➔ = Contains updated information.

4067-982 7/17

1 Product Specific and Important Safety Information

A. Appliance Certification

MODELS: CARODG36I-C, CARODG42I-C

LABORATORY: Underwriters Laboratories, Inc. (UL)

TYPE: Outdoor Decorative Gas Appliances

STANDARD: ANSI Z21.97-2014, CSA 2.41-2014

This product is listed to ANSI standards for “Outdoor Decorative Gas Appliances” and “Gas Fired Appliances for Use at High Altitudes.”

NOTICE: This installation must conform with local codes. In the absence of local codes you must comply with the *National Fuel Gas Code, ANSI Z223.1-latest edition in the U.S.A. and the CAN/CGA B149 Installation Codes in Canada.*

When an appliance is for connection to a fixed piping system, the installation must conform with local codes, or in the absence of local codes with the *National Fuel Gas Code, ANSI Z223.1/NFPA 54, or International Fuel Gas Code.*

B. BTU Specifications

Models	Maximum Input BTUH	Orifice Size (DMS)
CARODG36I-C (NG)	55,000	#27 / .144
CARODG36I-C (LP)	50,000	#46 / .081
CARODG42I-C (NG)	65,000	#24 / .152
CARODG42I-C (LP)	62,000	#43 / .089

C. High Altitude Installations

NOTICE: If the heating value of the gas has been reduced, these rules do not apply. Check with your local gas utility or authorities having jurisdiction.

When installing above 2000 feet elevation:

- In the USA: Reduce input rate 4% for each 1000 feet above 2000 feet.
- In CANADA: Input ratings are certified without a reduction of input rate for elevations up to 4500 feet (1370 m) above sea level. Please consult provincial and/or local authorities having jurisdiction for installations at elevations above 4500 feet (1370 m).

Check with your local gas utility to determine proper orifice size.

D. Non-Combustible Materials Specification

Material which will not ignite and burn. Such materials are those consisting entirely of steel, iron, brick, tile, concrete, slate, glass or plasters, or any combination thereof.

Materials that are reported as passing **ASTM E 136, Standard Test Method for Behavior of Materials in a Vertical Tube Furnace at 750 °C** shall be considered non-combustible materials.

E. Combustible Materials Specification

Materials made of or surfaced with wood, compressed paper, plant fibers, plastics, or other material that can ignite and burn, whether flame proofed or not, or plastered or unplastered shall be considered combustible materials.

F. Electrical Codes

NOTICE: This appliance must be electrically wired and grounded in accordance with local codes or, in the absence of local codes, with **National Electric Code ANSI/NFPA 70-latest edition or the Canadian Electric Code CSA C22.1.**

- A 110-120 VAC circuit for this product must be protected with ground-fault circuit-interrupter protection, in compliance with the applicable electrical codes, when it is installed in locations such as in bathrooms or near sinks.

G. Fuel

This appliance must not be used to burn solid fuel.

2 Getting Started

A. Design and Installation Considerations

The Carolina Series outdoor gas appliance is designed for outdoor use and may be installed as a stand-alone unit or built into an outside wall. It may be installed in screened porches and lanais that meet these minimum requirements:

- Minimum porch area - 96 square feet
- Minimum ceiling height - 82 in.
- Minimum distance from top of appliance opening to ceiling - 49.5 in.

A minimum of one wall can be screened but must be open to outside ventilation. Minimum requirements are:

- Minimum screen area - 64 square feet
- Minimum screen top height - 80 in.

If this appliance is to be installed within a wall, you must:

- Provide access to the gas controls.
- Slope outdoor floor (and hearth) away from appliance.
- Flash the perimeter of the appliance, corners and the appliance face in a manner consistent with regional practices as required to prevent water penetration around the appliance or manage water that may penetrate the appliance. See Section 3 for more information regarding wall and enclosure construction.

The appliance may be installed on a wood or non-combustible deck.

Refer to Section 3 for clearances.

Installation MUST comply with local, regional, state and national codes and regulations. Consult insurance carrier, local building inspector, fire officials or authorities having jurisdiction over restrictions, installation inspection and permits.

Before installing, determine the following:

- Where the appliance is to be installed.
 - Clearance to side walls
 - Location of adjacent stairwells
 - Doors
 - Windows
 - Walkways
 - Wires
 - Possibility of flooding or running water
- Gas supply piping requirements.
- Electrical wiring requirements.
- Framing and finishing details.

Installation and service of this appliance should be performed by qualified personnel. Hearth & Home Technologies recommends NFI certified professionals.



Improper installation, adjustment, alteration, service or maintenance can cause injury or property damage. For assistance or additional information, consult a qualified service technician, service agency or your dealer.

B. Tools and Supplies Needed

Before beginning the installation be sure that the following tools and building supplies are available.

Tape measure	Framing material
Pliers	Hammer
Phillips screwdriver	Manometer
Gloves	Framing square
Voltmeter	Electric drill and bits (1/4 in.)
Plumb line	Safety glasses
Level	Reciprocating saw
3/4 in. wrench	Crescent wrench
7/8 in. wrench	1/4 in. nut driver
7/16 in. wrench	Pipe sealant
Flat blade screwdriver	
Non-corrosive leak check solution	
1/2 - 3/4 in. length, #6 or #8 Self-drilling screws	
Caulking material (300 °F minimum continuous exposure rating)	

C. Inspect Appliance and Components

- Carefully remove the appliance and components from the packaging.
- Remove screen package from grate, set aside.
- Remove packaging from gas logs and lava rock, which are packaged separately and located on top of the firebox along with the lava rock.
- Report any parts damaged in shipment to your dealer.
- **Read all of the instructions before starting the installation. Follow these instructions carefully during the installation to ensure maximum safety and benefit.**

WARNING! Risk of Fire or Explosion! Damaged parts could impair safe operation. **DO NOT** install damaged, incomplete or substitute components. Keep appliance dry.

Hearth & Home Technologies disclaims any responsibility for, and the warranty will be voided by, the following actions:

- Installation and use of any damaged appliance or vent system component.
- Modification of the appliance.
- Installation other than as instructed by Hearth & Home Technologies.
- Improper positioning of the gas logs.
- Installation and/or use of any component part not approved by Hearth & Home Technologies.

Any such action may cause a fire hazard.

WARNING! Risk of Fire, Explosion or Electric Shock! **DO NOT** use this appliance if any part has been under water. Call a qualified service technician to inspect the appliance and to replace any part of the control system and/or gas control which has been under water.

3 Framing and Clearances

A. Appliance/Decorative Front Dimension Diagrams

Dimensions are actual appliance dimensions. Use for reference only.

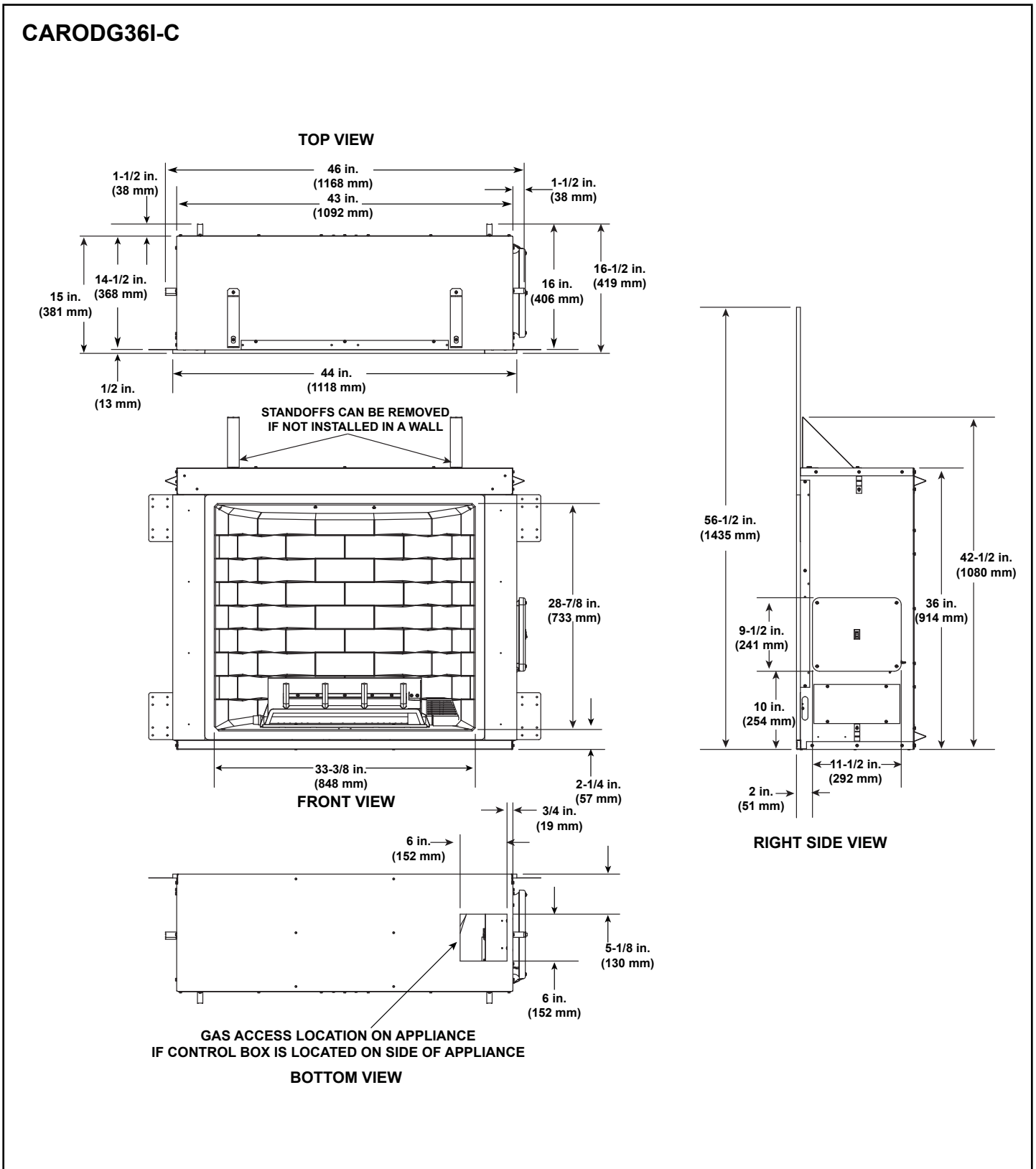

Figure 3.1 Appliance Dimensions - CARODG36I-C

CARODG42I-C

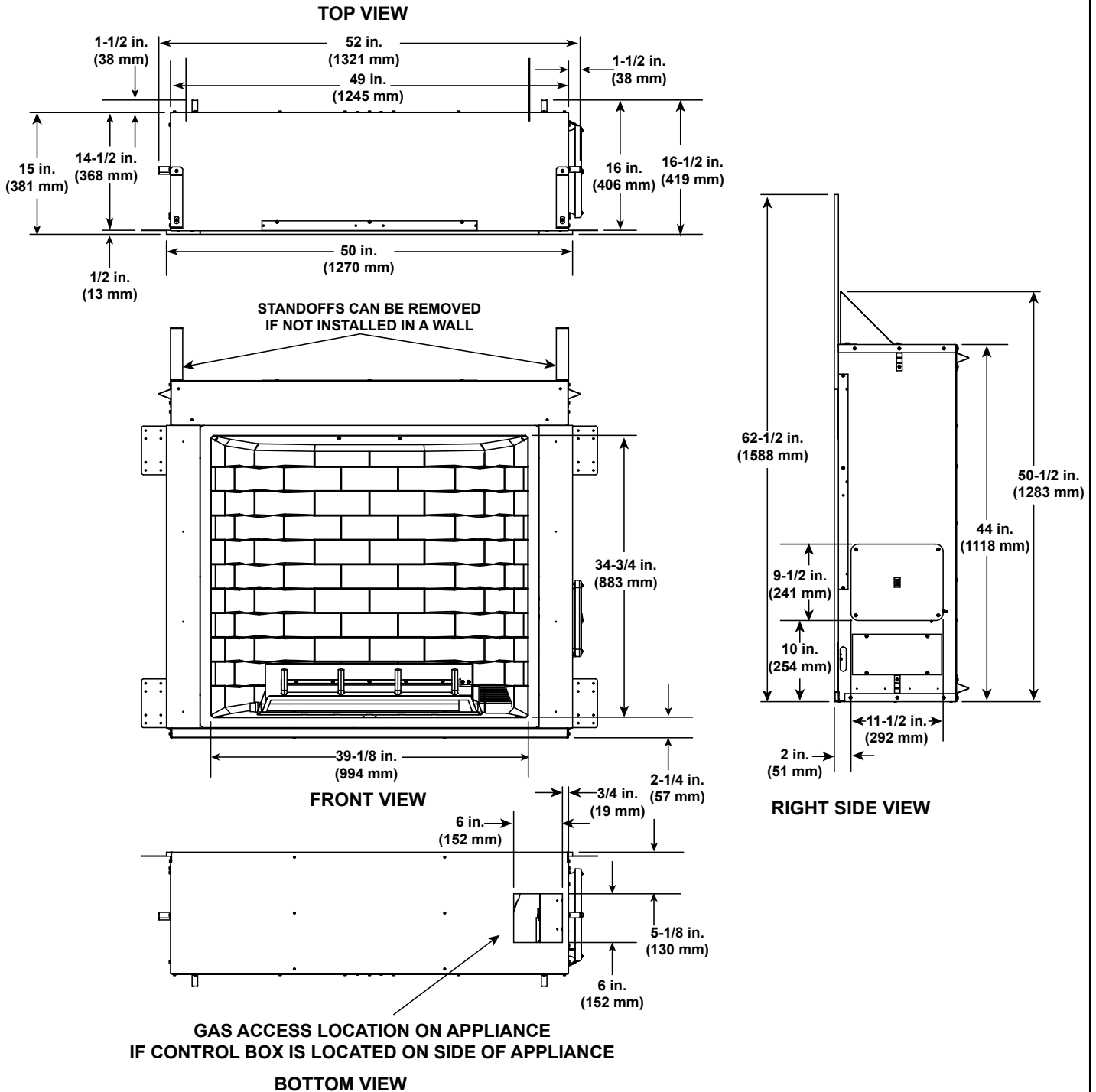

Figure 3.2 Appliance Dimensions - CARODG42I-C

B. Clearances to Combustibles

When selecting a location for the appliance it is important to consider the required clearances to walls. See Figure 3.3, Figure 3.4 and Figure 3.5.

WARNING! Risk of Fire or Burns! *Provide adequate clearance around air openings and for service access. Due to high temperatures, the appliance should be located out of traffic and away from furniture and draperies.*

WARNING! Risk of Fire or Burns! *The appliance is hot and wind may cause flames to reach out in front.*

- Keep furniture, draperies and other combustibles away.
- Locate the appliance away from traffic areas.
- Do not block air openings.
- DO NOT place rugs, carpeting or other combustible materials on the floor directly in front of the appliance.
- Clean up fallen leaves, branches and other combustible materials before using the appliance.
- See Figure 3.3, Figure 3.4 and Figure 3.5 for required clearances.
- Install on wood or solid non-combustible surfaces extending full width and depth to prevent damage.
- **DO NOT** install directly on carpeting, vinyl, plastic composite decking or combustible surfaces other than wood.
- When installed on wood, a 16" non-combustible hearth extension in front of the appliance is recommended. See Figure 3.5.

WARNING! Risk of Fire! *Maintain specified air space clearances to appliance:*

- *Insulation and other materials must be secured to prevent accidental contact.*
- *The chase/enclosure must be properly blocked to prevent blown insulation or other combustibles from entering and making contact with the appliance.*
- *Failure to maintain airspace may cause overheating and a fire.*

CARODG36I-C

NOTICE: Illustrations reflect typical installations and are FOR DESIGN PURPOSES ONLY. Illustrations/diagrams are not drawn to scale. Actual installation may vary due to individual design preference.

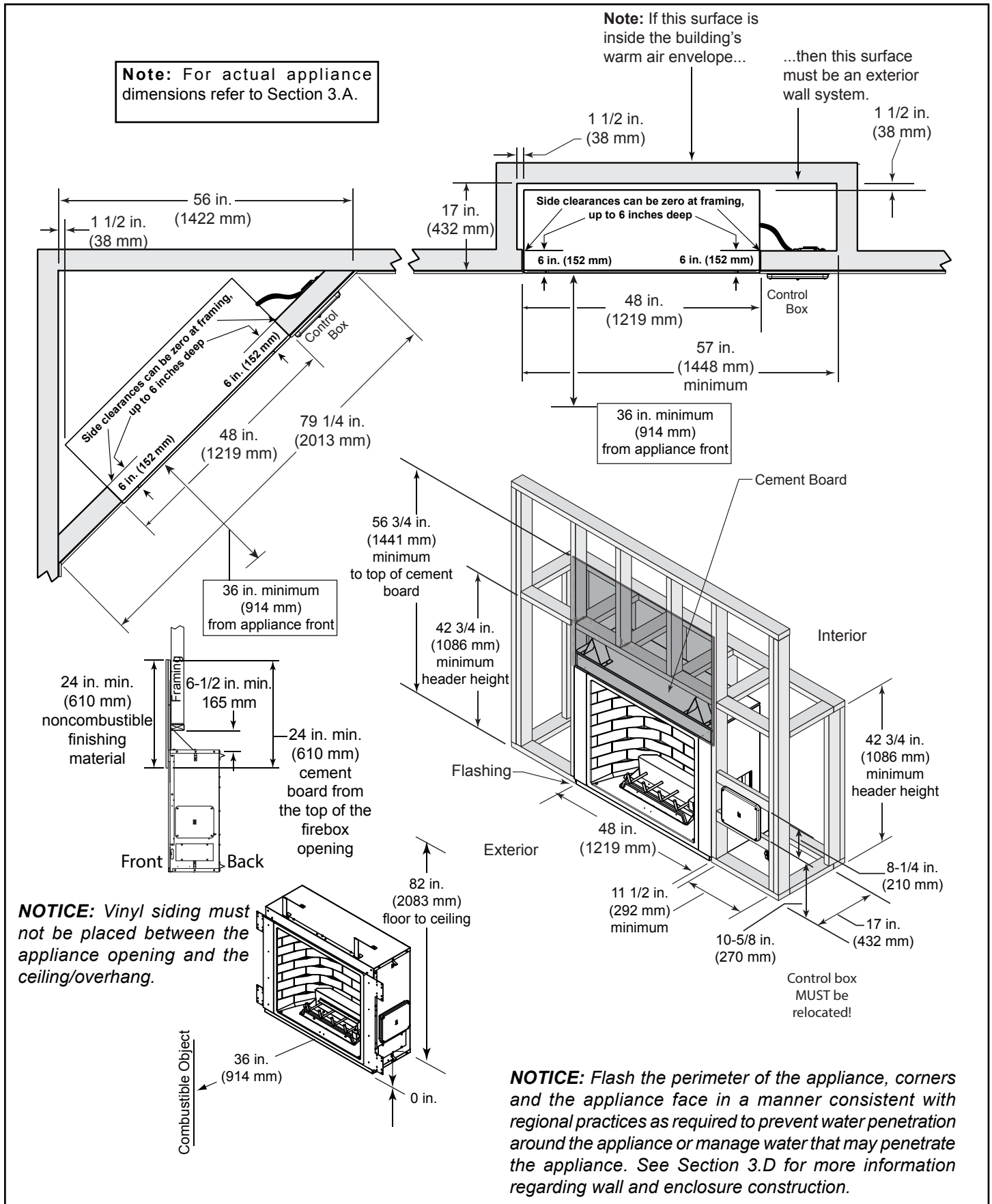

Figure 3.3 Appliance Locations and Framing Dimensions - CARODG36I-C

CARODG42I-C

NOTICE: Illustrations reflect typical installations and are FOR DESIGN PURPOSES ONLY. Illustrations/diagrams are not drawn to scale. Actual installation may vary due to individual design preference.

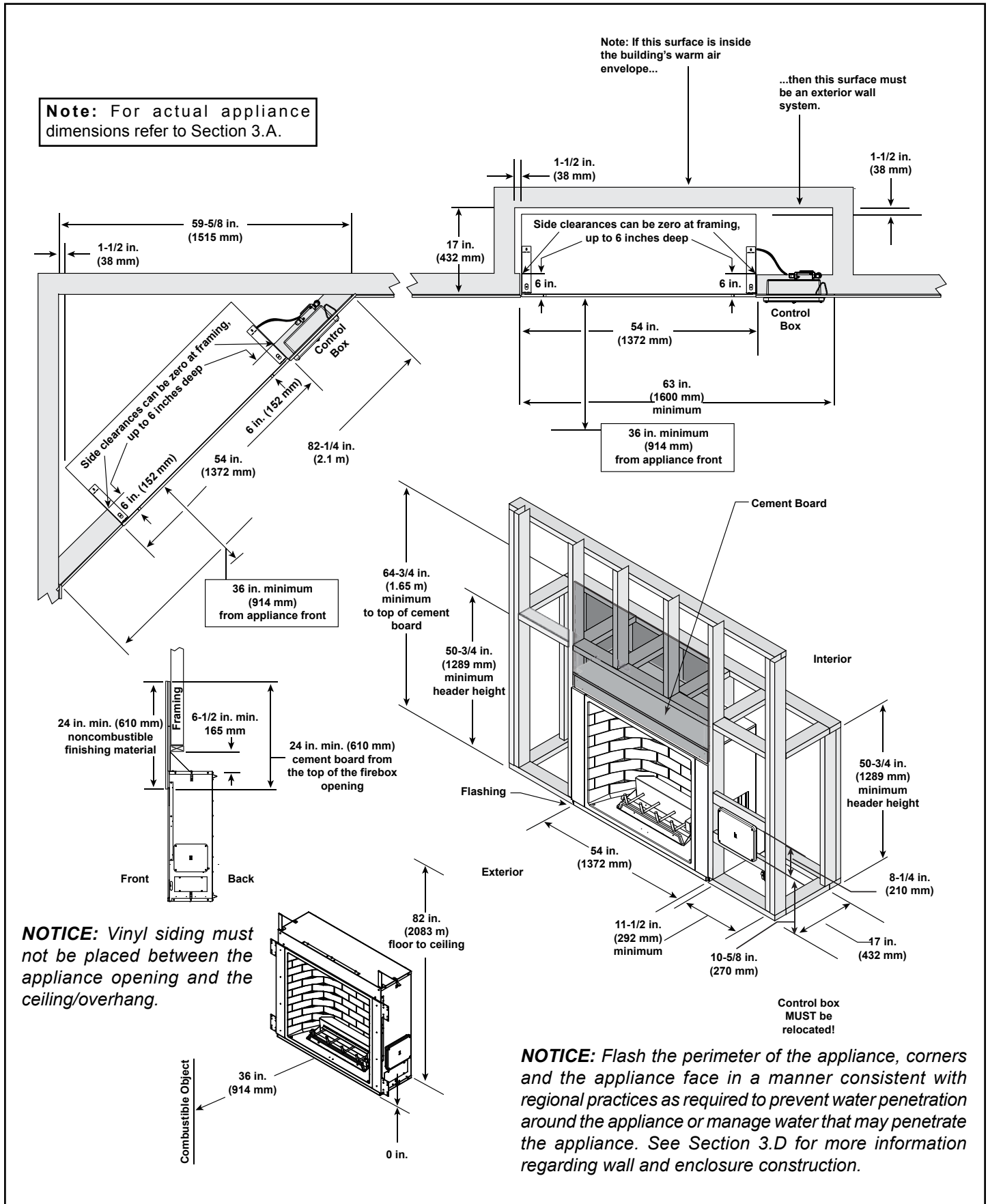

Figure 3.4 Appliance Locations and Framing Dimensions - CARODG42I-C

WARNING! Risk of Fire! Comply with all minimum clearances to combustibles as specified. Framing or finishing material closer than the minimums listed must be constructed entirely of non-combustible materials (i.e., steel studs, concrete board, etc).

Note: Clearance to a window or door that may be opened = 12 inches (305 mm)

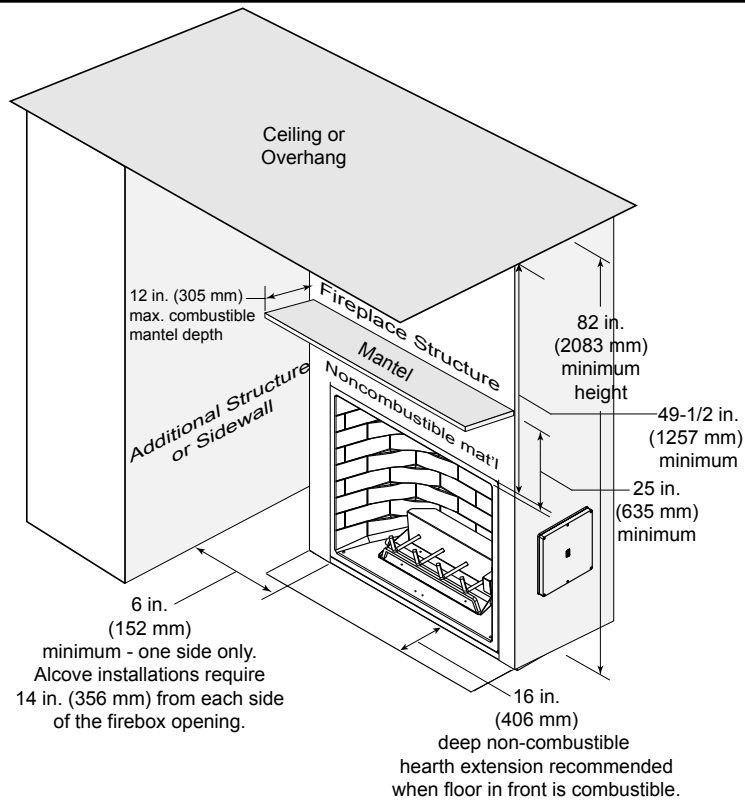

Figure 3.5 Clearances to Combustibles

C. Hearth Extension/Floor Protection

WARNING! Risk of Fire! Hearth extension recommended to protect combustible floors in front of appliance.

D. Stand-Alone Installation

This appliance may be installed as a stand-alone unit.

- Construct a stand-alone surround of non-combustible materials.
- Cement board or other non-combustible material can be applied directly to the metal and covered with non-combustible facing material.
- Air space clearances are not required for stand-alone construction with non-combustible materials.
- Tape and seal all joints and corners.
- Provide proper flashing and moisture management if installed on surfaces that may rot or otherwise be damaged by water. (See also Section 3.F.)

When the stand-alone surround is constructed completely of non-combustible materials, stand-offs may be removed to permit a smaller structure.

E. Built-in Installation

When this appliance is installed into a wall, we recommend that the wall be an exterior wall system.

- See framing measurements in Figure 3.3 and 3.4.
- You must maintain 1 ½ in. (38mm) air space at the back and sides (except the first 6 inches from the front can be zero to the framing). See Figures 3.3 and 3.4.
- The header must not be placed below the top of the top standoffs.
- Non-combustible wall sheathing material is required the first 24 inches above the top of the firebox opening.

- A 24 inch tall cement board has been provided for this installation and has been fastened to the back of the appliance for shipping purposes.
- Put a bead of caulking material across the top of the firebox flange before installing 24 inch tall cement board.
- The control box **MUST** be relocated to be easily accessible. See Section 5.C.
- Flash the perimeter of the appliance, corners and the appliance face in a manner consistent with regional practices as required to prevent water penetration around the appliance or manage water that may penetrate the appliance. See Section 3.D and Figure 3.1 (CARODG36I-C) and Figure 3.2 (CARODG42I-C) for more information regarding wall and enclosure construction.

F. Moisture Resistance

This outdoor appliance will shed moderate amounts of water, but is not waterproof. This appliance must be enclosed or covered with non-combustible finish material and all joints sealed to prevent water infiltration.

The firebox will not perform as an exterior wall. Moisture penetration must be considered for construction that places the appliance in structure walls or on moisture sensitive surfaces.

When installed on exterior walls: Hearth & Home Technologies recommends that the chase be constructed outside the structure's weather envelope. Where the platform meets the wall, use a flashing detail similar to that required for attached decks. Chase platforms, including hearths should slope away from the structure at 1/8 in. to 1/4 in. per foot. The appliance can be shimmed level.

4 Appliance Preparation

A. Securing and Leveling Appliance

CAUTION! Risk of Cuts, Abrasions or Flying Debris. Wear protective gloves and safety glasses during installation. Sheet metal edges are sharp.

Position, level, and secure the appliance.

- Place the appliance into position on either a wood or non-combustible continuous flat surface.
- Level the appliance from side to side and front to back.
- Shim the appliance with non-combustible material, such as sheet metal, as necessary.
- Nailing tabs must be moved from shipping position to installation position and secured to framing. Bend the two nailing tabs out on each side. See Figure 4.1.

B. Flashing

- Flash the appliance in a manner consistent with regional practices to prevent water penetration around the appliance. Due to elevated temperatures across the top of the appliance, metal flashing and high temperature sealant must be used. Adhesive polymeric flashing materials may melt.
- For brick, stone, stucco and similar construction, weep screeds should be installed per regional codes.
- See Section 3.F and Figures 3.1 and 3.2 for more information regarding wall and enclosure construction required to prevent moisture penetration into the structure. The appliance will shed moderate amounts of water but is not waterproof.

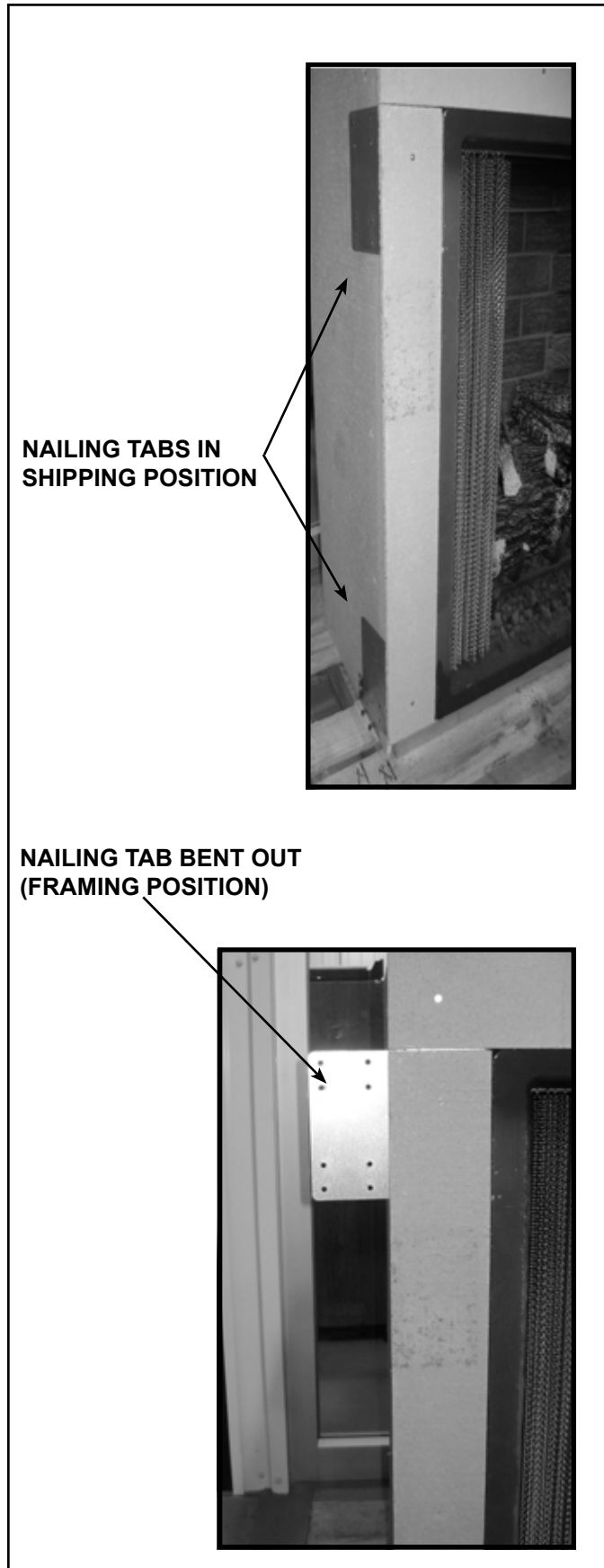

Figure 4.1 Positioning and Securing Nailing Tab

5 Electrical Information

A. General Information

Note: If a gas conversion is to be done on this appliance, it should be done before electrical connections are made. See Section 6 Gas Information.

WARNING! Risk of Shock or Explosion! DO NOT wire 110-120 VAC to the valve or to the appliance wall switch. Incorrect wiring will damage controls.

NOTICE: This appliance must be electrically wired and grounded in accordance with local codes or, in the absence of local codes, with **National Electric Code ANSI/NFPA 70-latest edition** or the **Canadian Electric Code CSA C22.1**.

- Wire the appliance junction box to unswitched 110-120 VAC. This is required for proper operation of the appliance.
- A 110-120 VAC circuit for this product must be protected with ground-fault circuit-interrupter protection in compliance with the applicable electrical codes.
- Low voltage and 110-120 VAC voltage cannot be shared within the same wall box.

Electrical Service and Repair

WARNING! Risk of Shock! Label all wires prior to disconnection when servicing controls. Wiring errors could cause improper and dangerous operation. Verify proper operation after servicing.

WARNING! Risk of Shock! Replace damaged wire with type 105° C rated wire. Wire must have high temperature insulation.

B. Wiring Requirements

IntelliFire™ Ignition System Wiring

- Wire the appliance junction box to 110-120 VAC for proper operation of the appliance.

WARNING! Risk of Shock or Explosion! DO NOT wire IPI controlled appliance junction box to a switched circuit. Incorrect wiring will override IPI safety lockout.

- Refer to Figure 5.10, IntelliFire™ Pilot Ignition (IPI) Wiring Diagram.
- This appliance is equipped with an IntelliFire™ control module which operates on a 3 volt system.
- Plug the 3-volt AC transformer into the appliance junction box to supply power to the appliance.

C. Installing the Electric Kit

- Remove four screws to remove cover from the control box.



Figure 5.1 Remove Control Cover

- Remove the junction box bracket by prying loose with a screwdriver. Deburr bracket and valve bracket. Remove the two screws shown in Figure 5.2. Cut out and remove insulation from behind junction box bracket as shown in Figure 5.3.

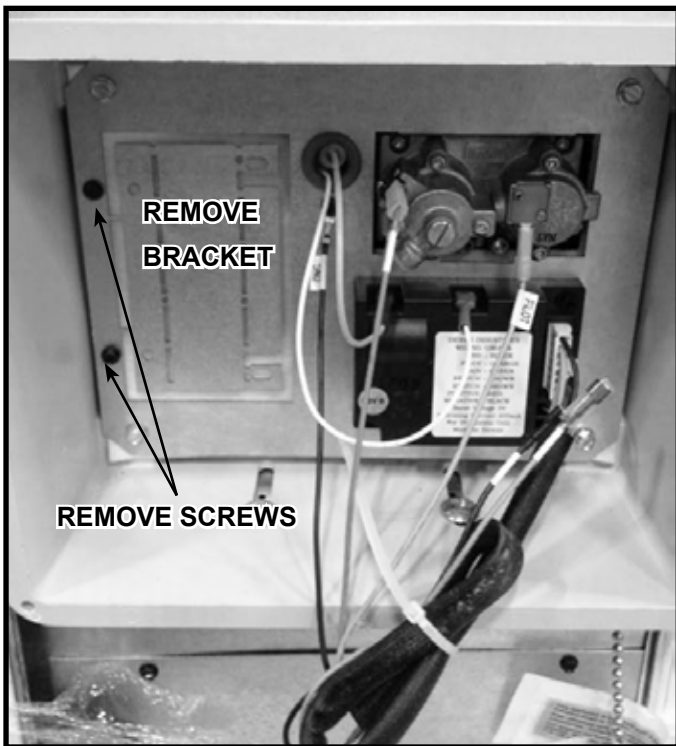

Figure 5.2 Remove Junction Box Bracket & Two Screws

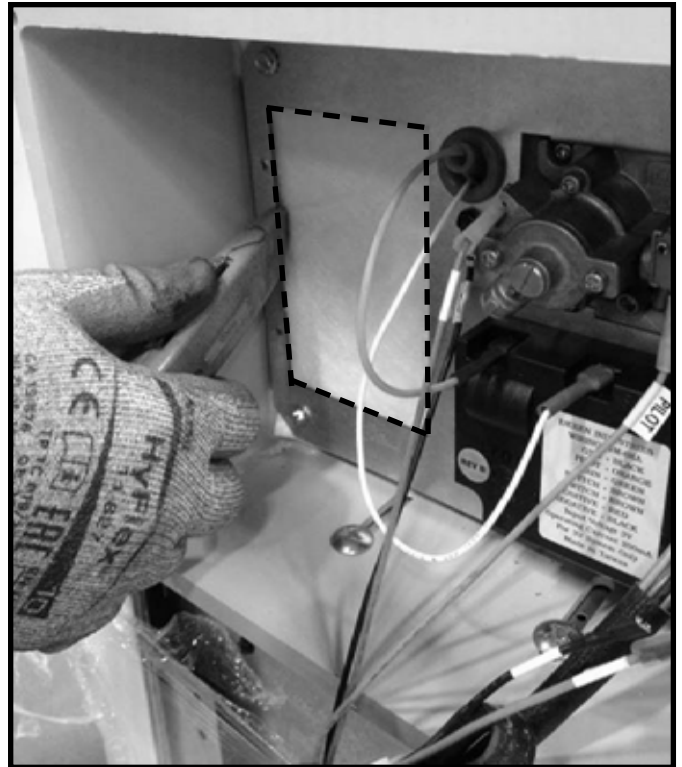

Figure 5.3 Cut and Remove Insulation

- Make hand bends to bracket as shown in Figure 5.4:



Figure 5.4 Hand-bend Bracket

- Fasten bracket to junction box with two screws (provided with junction box).

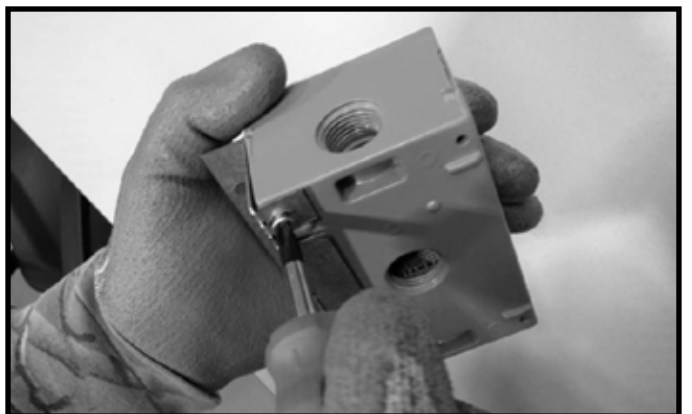

Figure 5.5 Fasten Bracket to Junction Box

- Thread wire into junction box.
- Place junction box into the control box, matching holes as shown, and fasten with the two screws removed in Figure 5.2.

- Assemble the junction box.



Figure 5.6 Place & Fasten Junction Box

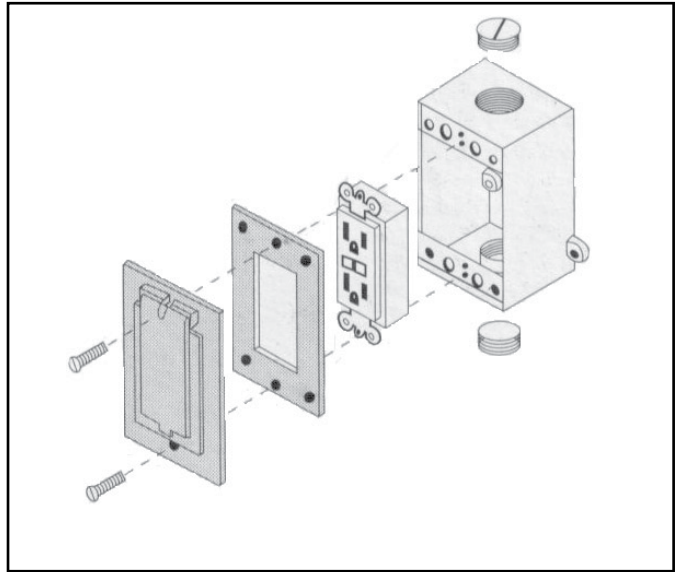

Figure 5.8 Assemble Junction Box

- Wire the GFI receptacle as shown below:

- Ensure that the two wires from the power supply are plugged into the control module as shown in Figure 5.10.
- Plug the transformer end of the power supply into the outlet.
- Replace the cover on the control box. See Figure 5.9.

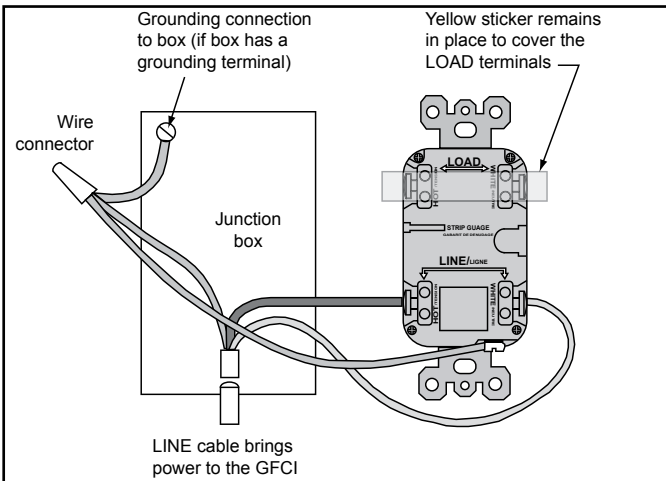

Figure 5.7 Wire the GFI Receptacle



Figure 5.9 Replace Control Cover

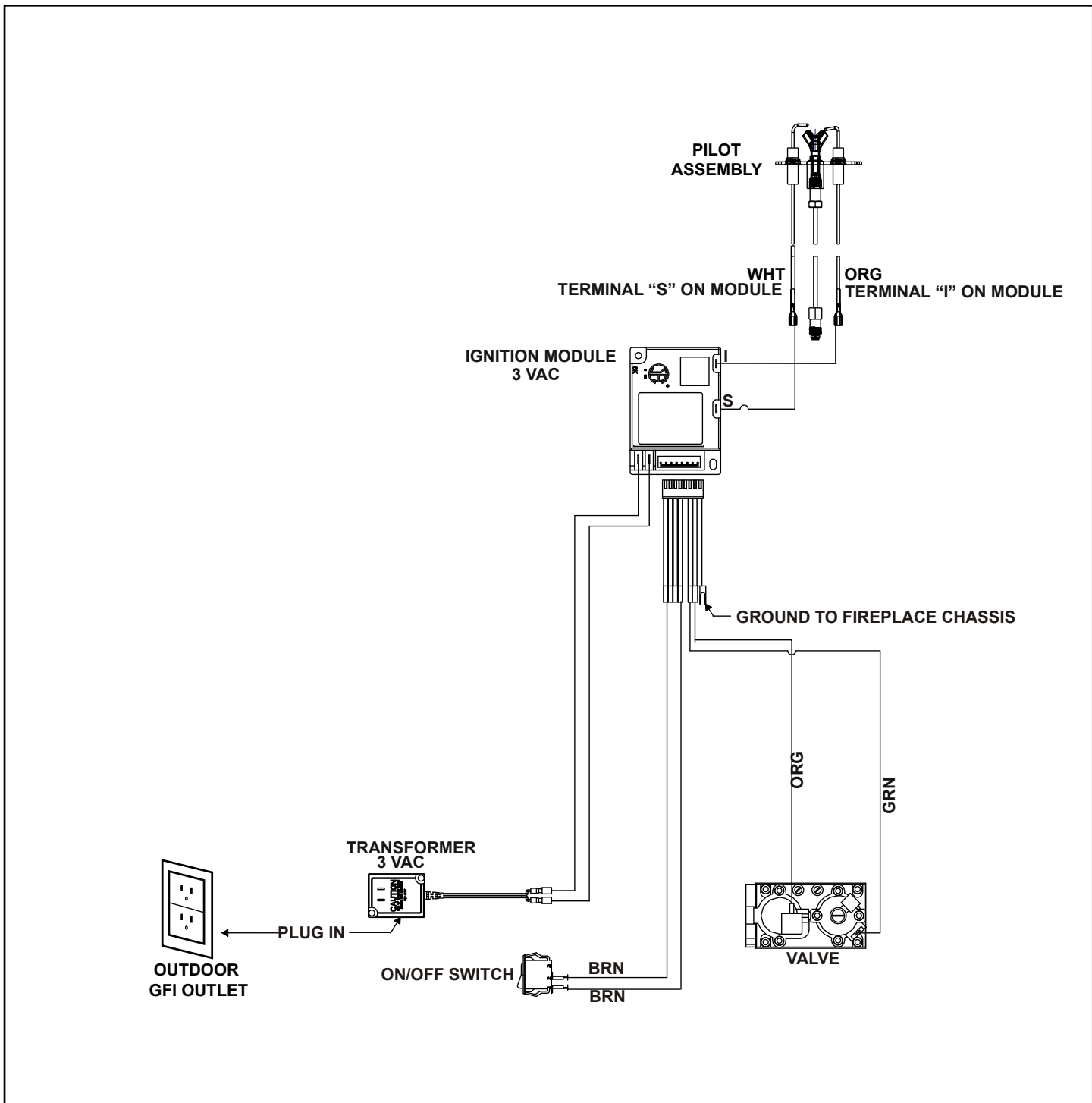

Figure 5.10 Intermittent Pilot Ignition (IPI) Wiring Diagram

6 Gas Information

A. Fuel Conversion

- Make sure the appliance is compatible with available gas types.
- Conversions must be made by a qualified service technician using Hearth & Home Technologies specified and approved parts.

B. Gas Pressure

- Optimum appliance performance requires proper input pressures.
- Gas line sizing requirements will be determined in ANSI Z223.1 National Fuel Gas Code in the USA and CAN/CGA B149 in Canada.
- Pressure requirements are:

Gas Pressure	Natural Gas	Propane
Minimum inlet pressure	5.0 in. w.c.	11.0 in. w.c.
Maximum inlet pressure	10.0 in. w.c.	13.0 in. w.c.
Manifold pressure	3.5 in. w.c.	10.0 in. w.c.

These pressures can be verified through the access panel as shown in Section 6.D Valve Access.

When an appliance is for connection to a fixed piping system, the installation must conform with local codes, or in the absence of local codes with the **National Fuel Gas Code, ANSI Z223.1/NFPA 54, or International Fuel Gas Code.**

WARNING! Risk of Fire or Explosion! High pressure will damage valve. Low pressure could cause explosion.

- Verify inlet pressures. Verify minimum pressures when other household gas appliances are operating.
- Install regulator upstream of valve if line pressure is greater than 1/2 psig.

⚠ WARNING



Fire Risk.
Explosion Hazard.
High pressure will damage valve.

- Disconnect gas supply piping BEFORE pressure testing gas line at test pressures above 1/2 psig.
- Close the manual shutoff valve BEFORE pressure testing gas line at test pressures equal to or less than 1/2 psig.

Note: Have the gas supply line installed in accordance with local codes, if any. If not, follow ANSI 223.1. Installation should be done by a qualified installer approved and/or licensed as required by the locality. (In the Commonwealth of Massachusetts installation must be performed by a licensed plumber or gas fitter).

Note: A listed (and Commonwealth of Massachusetts approved) 1/2 in. (13 mm) T-handle manual shut-off valve and flexible gas connector are connected to the 1/2 in. (13 mm) control valve inlet.

- **If substituting for these components, please consult local codes for compliance.**

C. Gas Connection

- If control box is to be relocated, move it at this time to avoid making the gas connection more than once.
- Refer to Reference Section 3 for location of gas line access in appliance.
- Gas line may be run through knockout(s) provided.

Note: Gas line **MUST** be run from right side of appliance.

- The gap between supply piping and gas access hole may be caulked with caulk with a minimum of 300 °F continuous exposure rating or stuffed with non-combustible, unfaced insulation to prevent cold air infiltration.
- Ensure that gas line does not come in contact with outer wrap of the appliance. Follow local codes.
- Pipe incoming gas line into valve compartment.
- Connect incoming gas line to the 1/2 in. (13 mm) connection on manual shutoff valve.

WARNING! Risk of Fire or Explosion! Support control when attaching pipe to prevent bending gas line.

- A small amount of air will be in the gas supply lines.
- Light the appliance. It will take a short time for air to purge from lines. When purging is complete the appliance will light and operate normally.

WARNING! Risk of Fire! DO NOT change valve settings. This valve has been preset at the factory.

The access panel is located below the control box. It will be easier to make gas connection after the control box is in its final position. If necessary, relocate control box prior to making gas connection. See Section 6.D.

- Remove the screws holding the access panel.
- Set the panel and screws aside for reinstallation.

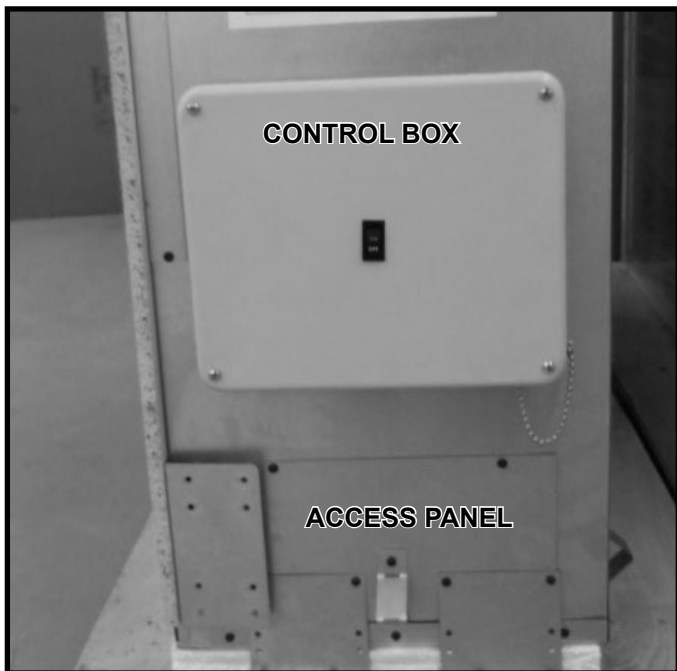

Figure 6.1 Control Box & Access Panel Locations

- The incoming gas line can be installed from the bottom of the appliance structure, from the side or from the rear.
- The incoming line should be connected to the 1/2 in. connection on the manual shutoff valve provided with the appliance.
- Cut cable ties holding manual shutoff valve and the flex line and pilot line prior to finishing to allow for easy access.

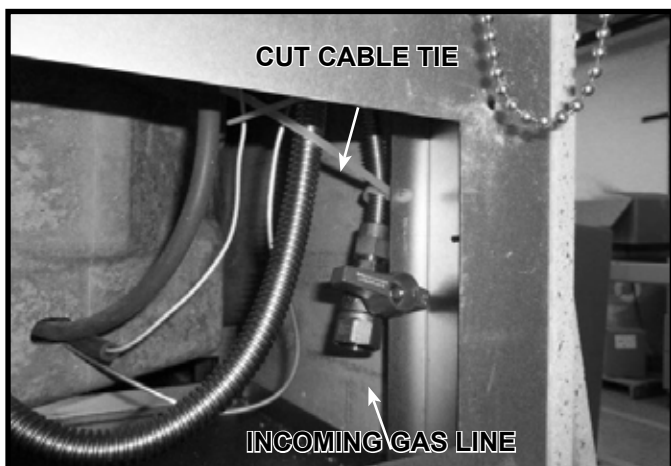

Figure 6.2 Connect Incoming Gas Line to Manual Shutoff Valve

- Accessibility to the shutoff valve is required after installation, or another accessible shutoff is required.

- The flex line and gas shutoff valve can be accessed after installation by removing four screws from the valve mounting bracket at the rear of the control box.

WARNING! Risk of Fire, Explosion or Asphyxiation! Check all fittings and connections with a non-corrosive commercially available leak-check solution. **DO NOT** use open flame. Fittings and connections could have loosened during shipping and handling.

WARNING! Risk of Fire or Explosion! Gas build-up during line purge could ignite.

- Purge should be performed by qualified service technician.
- Ensure adequate ventilation.
- Ensure there are no ignition sources such as sparks or open flames.

D. Valve Access

The valve and controls are located in the control box (Refer to Figure 6.1). Remove the screws and remove the lid.

The control box is designed to be moved out to allow for the thickness of the finish material or moved from the appliance and repositioned.

- Loosen the two bolts found inside the box in the bottom of the control box.
- Slide the box out as necessary.
- Tighten the screws.
- The control box can be removed from the appliance and repositioned (up to approximately 4-1/2 ft. from the appliance).

WARNING! Risk of Fire! Risk of Explosion! DO NOT allow gas line to kink or bend while relocating control box. Gas could leak.

- Make sure the lid will fit over the box without interfering with the finish material.
- The control box lid must be accessible and removable.
- Caulk around the perimeter of the box to prevent water infiltration.

Note: The control box lid can be painted as desired. Use sandpaper or other abrasive material to scuff the surface prior to painting.

E. High Altitude Installations

NOTICE: If the heating value of the gas has been reduced, these rules do not apply. Check with your local gas utility or authorities having jurisdiction.

When installing above 2000 feet elevation:

- In the USA: Reduce input rate 4% for each 1000 feet above 2000 feet.
- In CANADA: Input ratings are certified without a reduction of input rate for elevations up to 4500 feet (1370 m) above sea level. Please consult provincial and/or local authorities having jurisdiction for installations at elevations above 4500 feet (1370 m).

Check with your local gas utility to determine proper orifice size.

7 Finishing

A. Facing Material

The fireplace structure can be covered with any non-combustible material. Refer to Section 1.D.

It is possible for the face of the appliance above the appliance opening to show signs of soot. Clean that area as frequently as necessary to eliminate a build up of soot or permanent discoloration. A non-combustible ledge (shelf) approximately 3 inches above the opening and a minimum of 3 inches out from the face of the appliance incorporated into the facing material will help prevent the soot from going up the wall.

WARNING! Risk of Fire! DO NOT apply combustible materials beyond the minimum clearances. Comply with all minimum clearances to combustibles as specified in this manual. Overlapping materials could ignite.

Note: The control box lid can be painted as desired. Use sandpaper or other abrasive material to scuff the surface prior to painting.

B. Mantel and Wall Projections

WARNING! Risk of Fire! Comply with all minimum clearances to combustibles as specified. Framing or finishing material closer than the minimums listed must be constructed entirely of non-combustible materials (i.e., steel studs, concrete board, etc.).

Figure 7.1 shows the dimensions for mantels or other combustible projections above the appliance opening.

Notice Regarding Televisions

NOTICE: The temperatures above the fireplace opening will exceed the operating temperatures of a television. If installing a television above the fireplace opening, a mantel/projection or recessed area is required to protect the television. Consult the television owner's manual for maximum allowable operating temperature and verify the television location temperature with a thermometer before installing the television.

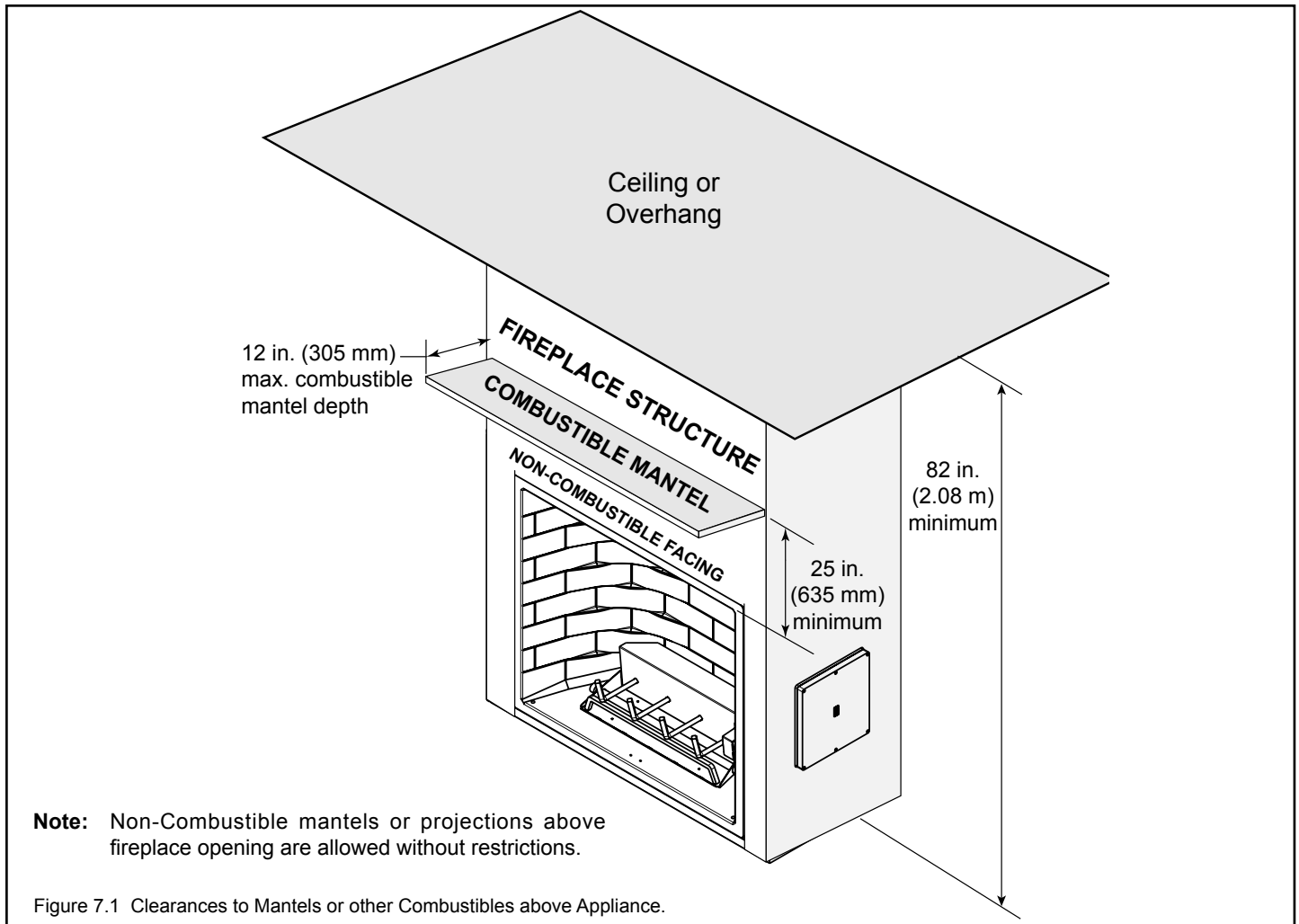

Figure 7.1 Clearances to Mantels or other Combustibles above Appliance.

8 Appliance Setup

A. Remove the Shipping Materials

Remove shipping materials from inside the firebox.

WARNING! Risk of Fire! Close the ball valve before installing the splatter guard to prevent accidental lighting. Remove the splatter guard before lighting the appliance.

B. Inspect Firebox

Surface cracking or crazing of firebrick material is normal and expected. All cracks are acceptable and do not require replacement of the unit or the firebox with the exception of:

- Cracks compromising the surface plane of the firebox. See Figure 8.1.

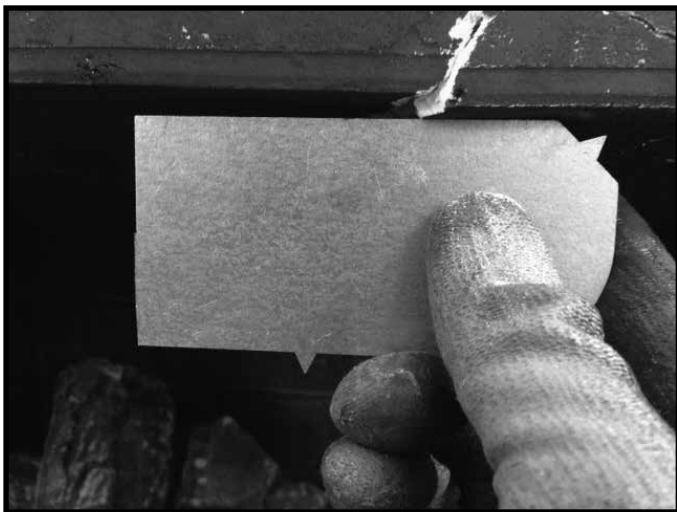

Figure 8.1 Surface plane of firebox is comprised and should be replaced.

C. Clean the Appliance

Clean/vacuum any sawdust that may have accumulated inside the firebox.

D. Optional Accessories

Install approved accessories per instructions included with accessories. Contact your dealer for a list of approved accessories.

WARNING! Risk of Fire and Electric Shock! Use ONLY Hearth & Home Technologies-approved optional accessories with this appliance. Using non-listed accessories could result in a safety hazard and will void the warranty.

E. Install Pilot Shield

Ensure the pilot shield is still in the position shown in Figure 8.2. Shipping could cause it to become displaced.

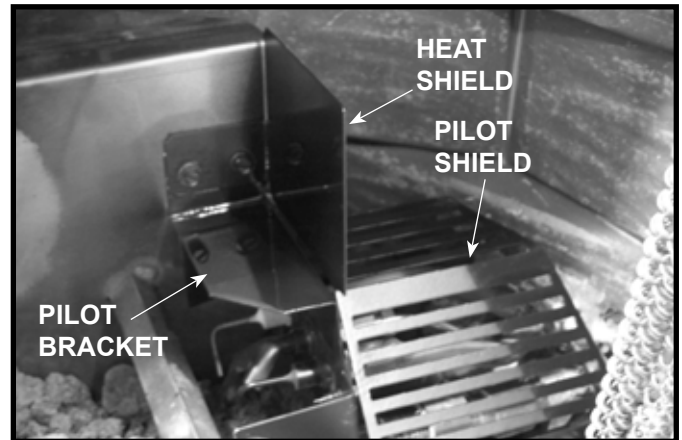

Figure 8.2 Pilot Shield Position

F. Install Lava Rock

Pour lava rock into the burner pan and cover the burner tube. The lava rock level should be at least to the bottom of grate tines, especially from the back side of the burner to the base pan, to reduce risk of sooting. DO NOT cover the burner tube from the right grate support to the pilot assembly. See Figure 8.3 and 8.4. There is extra rock provided to cover the front of the firebox if desired.

NOTICE! Do not cover area around pilot assembly with lava rock. Too much rock will interfere with pilot flame ignition, rectification, and wind stability.

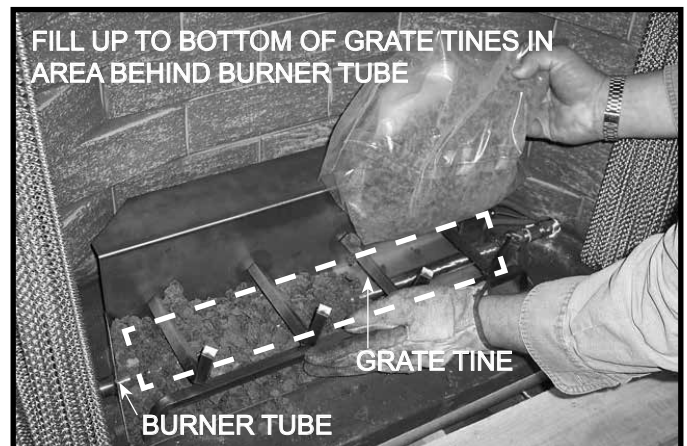

Figure 8.3 Install Lava Rock



Figure 8.4 Install Lava Rock

G. Install the Log Assembly

- Place the rear log on the shelf against the appliance rear wall. Position log as far back on the shelf as possible.

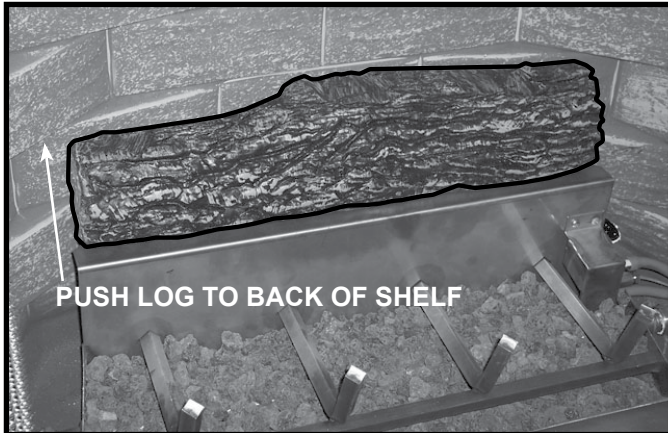

Figure 8.5 Place Rear Log

- Place the left front log on the grate against the front of the grate. Fit notch in log to grate bar as shown below.

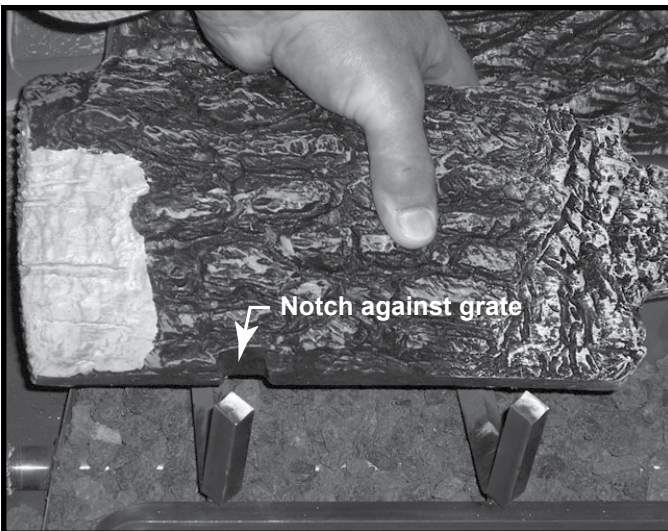

Figure 8.6 Place Left Front Log

- Place right front log on the grate against the front of the grate. Fit notches into the bottom of the log to position it as shown in Figure 8.7

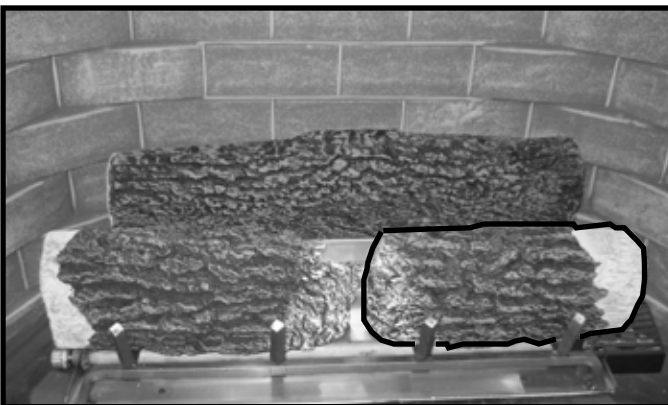

Figure 8.7 Place Right Front Log

- Place top left log on the indentations in the front left log and back log as shown in Figure 8.8.



Figure 8.8 Place Top Left Log

- Place the top right log on indentations in the front right log and back log as shown in Figure 8.8 .



Figure 8.9 Place Top Right Log

- Place top log on the front left log and the top left log as shown in Figure 8.10.



Figure 8.10 Place Top Log on Left Side

- Place the top log on the indentations of the right front log and the back log as shown in Figure 8.11 for Carolina-42.



Figure 8.11 Place Top Log in Center- Carolina 42

- Place the top log on the indentations of the left front log and the back log as shown in Figure 8.12 for Carolina-36.

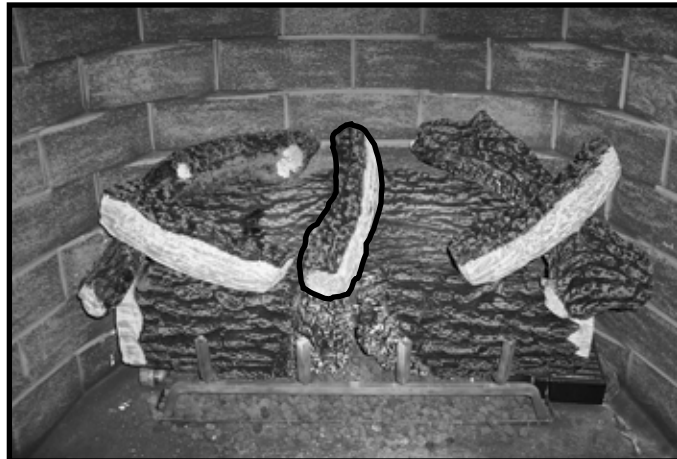

Figure 8.12 Place Top Log in Center- Carolina 36

- Place the top log on the indentations of the right front log and the right rear log as shown in Figure 8.13.



Figure 8.13 Place Right Center Log

H. Place Remaining Lava Rock

- After logs have been placed spread the remainder of the lava rock to cover the floor of the firebox.

I. Install Firescreen

Firescreen must be installed if not installing optional screen door.

- Remove screen and screen rods from packaging.
- Lay the two sides of screen side by side, rings on top, handles meeting in the middle.
- Insert one screen rod through the rings on top. See Figure 8.14.
- Repeat for other screen.

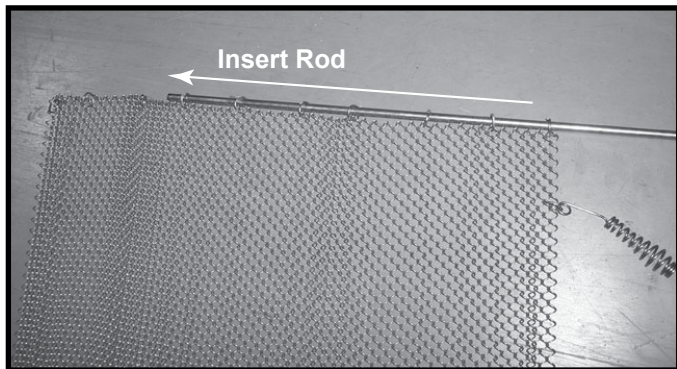

Figure 8.14 Insert Rod into Firescreen

- Remove two screws from the firebox top, set aside.

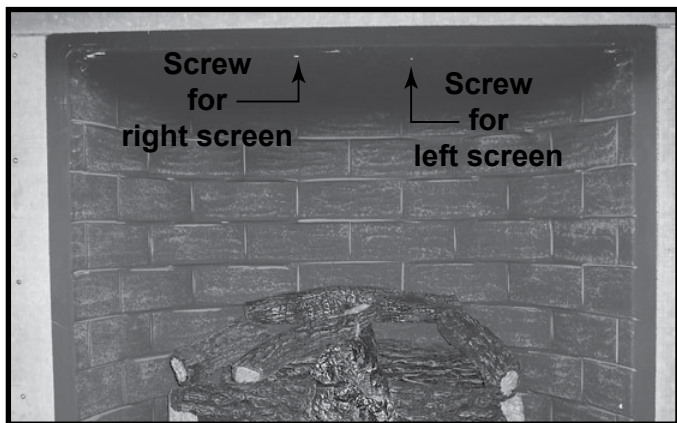

Figure 8.15 Remove Screws from Firebox Top

- Insert left end of the rod in the left screen (handle is on the right) into the hole in the upper left firebox side.

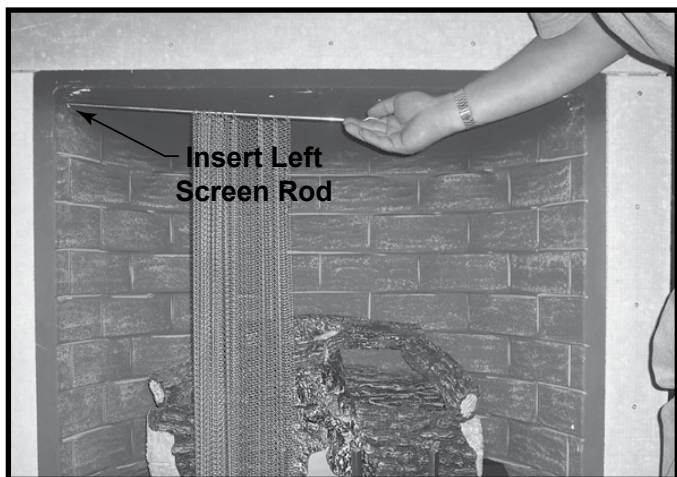

Figure 8.16 Insert Screen Rod

- Fasten rod with one of the screws removed from the firebox top, into the hole shown in Figure 8.15.



Figure 8.17 Fasten Screen Rod to Firebox Top

- Repeat with the right screen.

9 Reference Materials

A. Accessories

Optional Screen Door

Install approved screen door per instructions included with the product.

WARNING! Risk of Fire and Electric Shock! Use ONLY Hearth & Home Technologies-approved optional accessories with this appliance. Using non-listed accessories could result in a safety hazard and will void the warranty.

Outdoor Lifestyles, a brand of Hearth & Home Technologies
7571 215th Street West, Lakeville, MN 55044
www.hearthnhome.com

Please contact your Outdoor Lifestyles dealer with any questions or concerns.
For the location of your nearest Outdoor Lifestyles dealer,
please visit www.hearthnhome.com.

Printed in U.S.A. - Copyright 2017